

SBI Clerk 2022 Prelims Seating Arrangement Questions PDF



Direction: Study the following data carefully and answer the questions accordingly.

Six people M, N, O, P, Q, and R are sitting in a straight line but not necessarily in the same order. Some of them are facing the north direction and some are facing the south direction. P sits third to the right of O. Three people sit between M and O. M is not sitting at an end. N sits second to the right of M. Immediate neighbors of P face the opposite directions. N is not facing the south direction. R is not sitting at an end. Q and M face the opposite directions. R and Q face opposite directions. P and Q face the same direction.

1. Who sits immediate right of R?

- A. M
- B. O
- C. P
- D. N
- E. None of these

2. Who sits at the ends?

- A. Q, O
- B. O, M
- C. R, Q
- D. N, M
- E. None of these

3. Who sits second to the left of P?

- A. R
- B. M
- C. N
- D. O
- E. None of these

4. How many of them face the south direction?

- A. Four
- B. Three
- C. Two
- D. One
- E. None of these

5. Find the odd one.

- A. O
- B. N
- C. Q



SBI Clerk 2022
A Complete Course (Batch-8) (Hindi)
Clear the SBI Clerk Exam in First Attempt

START FREE TRIAL

- D. M
- E. P

Direction: Study the following data carefully and answer the questions accordingly.

Eight people are sitting around a square table. Four of them are sitting at the corners facing outside and the remaining four are sitting at the sides of the table facing inside. L sits second to the left of P. U sits opposite L. One person sits between H and U. W sits third to the right of H. O sits opposite G. R does not face outside. P is not a neighbor of G.

6. Who among the following sits opposite R?

- A. U
- B. H
- C. P
- D. W
- E. None of these

7. Who among the following sits second to the left of W?

- A. U
- B. G
- C. O
- D. H
- E. None of these

8. If G and H interchange their positions then what will be the position of R with respect to H?

- A. Immediate right
- B. Third to the left
- C. Immediate left
- D. Second to the right
- E. None of these

9. Find the correct statement/statements from the following.

- 1). H sits opposite P.
 - 2). W sits second to the left of G.
 - 3). U and R face the opposite directions.
- A. Only 1
 - B. Both 1 and 3
 - C. Both 2 and 3
 - D. Only 3
 - E. All are correct

10. Four from the following are similar in a certain way and forms a group. Find out the one, which does not belong to that group.

- A. G, O
- B. L, P
- C. R, W
- D. U, H
- E. L, O

Direction: Study the following data carefully and answer the questions accordingly.

Nine people are sitting around a circular table facing the center. Three people sit between J and R. One person sits between G and R. More than one person sits between J and G. N sits second to the right of G. L is an immediate neighbor of J. One person sits between T and L. One person sits between P and O, who is not an immediate neighbor of N. Z is not sitting immediate right of T.

11. Who sits third to the right of Z?

- A. R
- B. L
- C. O
- D. J
- E. None of these

12. Who are the immediate neighbors of N?

- A. Z, G
- B. P, O
- C. J, L
- D. P, J
- E. None of these

13. If R is related to G and J is related to Z then T is related to-

- A. P
- B. O
- C. G
- D. N
- E. None of these

14. What is the position of L from P?

- A. Fifth to the right
- B. Third to the left

- C. Third to the right
- D. Second to the left
- E. None of these

15. Find the correct statement/statements from the following.

- I. One person sits between R and Z.
 - II. N and G are immediate neighbors.
 - III. L sits second to the left of O.
- A. Both I and III
 - B. Only I
 - C. Both I and II
 - D. All are correct
 - E. None is correct

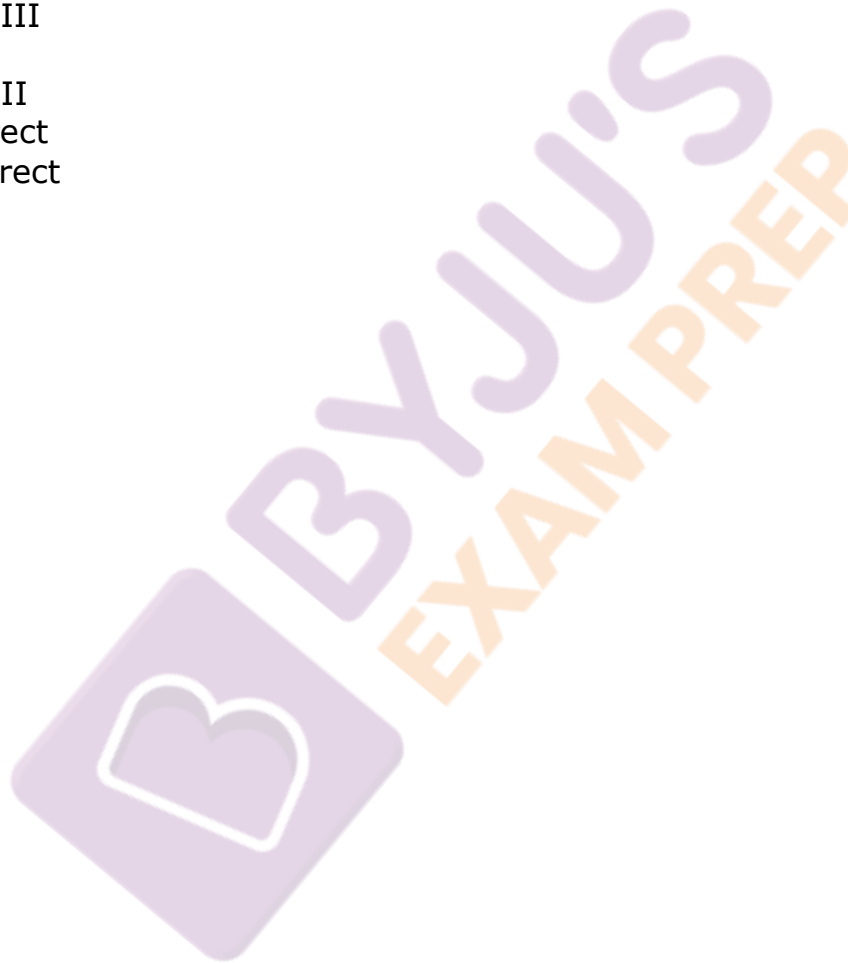

 **SBI Clerk 2022**
A Complete Course (Batch-8) (Hindi)
Clear the SBI Clerk Exam in First Attempt

[START FREE TRIAL](#)

###ANSWERS###

1. Ans. B.

1) P sits third to the right of O.

Case 1



Case 2



2) Three people sit between M and O.

3) M is not sitting at an end.

Case 1



Case 2



4) N sits second to the right of M.

5) Immediate neighbors of P face the opposite directions.

6) N is not facing the south direction.

(Here, case 2 will be eliminated and we will continue with the case 1)

Case 1



Case 2

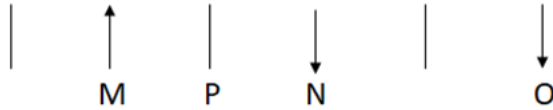

- 7) R is not sitting at an end.
- 8) Q and M face the opposite directions.
- 9) R and Q face opposite directions.
- 10) P and Q face the same direction.

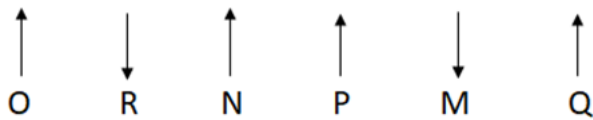

Therefore, option B is the correct answer.

2. Ans. A.

- 1) P sits third to the right of O.

Case 1



Case 2



- 2) Three people sit between M and O.
- 3) M is not sitting at an end.

Case 1



Case 2



- 4) N sits second to the right of M.
 - 5) Immediate neighbors of P face the opposite directions.
 - 6) N is not facing the south direction.
- (Here, case 2 will be eliminated and we will continue with the case 1)

Case 1

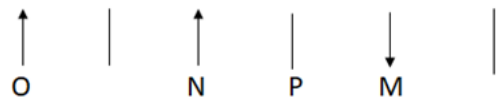

Case 2



- 7) R is not sitting at an end.
- 8) Q and M face the opposite directions.
- 9) R and Q face opposite directions.
- 10) P and Q face the same direction.

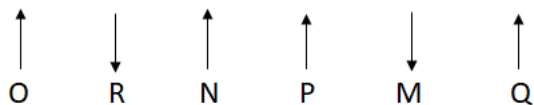

Therefore, option A is the correct answer.

3. Ans. A.

- 1) P sits third to the right of O.

Case 1



Case 2



- 2) Three people sit between M and O.
- 3) M is not sitting at an end.

Case 1



Case 2



- 4) N sits second to the right of M.
 - 5) Immediate neighbors of P face the opposite directions.
 - 6) N is not facing the south direction.
- (Here, case 2 will be eliminated and we will continue with the case 1)

Case 1



Case 2

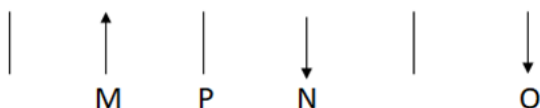

- 7) R is not sitting at an end.
- 8) Q and M face the opposite directions.

SBI Clerk 2022
A Complete Course (Batch-8) (Hindi)
Clear the SBI Clerk Exam in First Attempt

START FREE TRIAL

- 9) R and Q face opposite directions.
- 10) P and Q face the same direction.

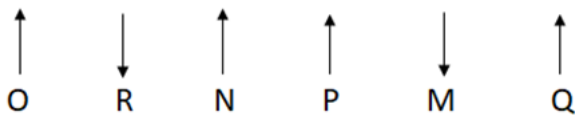

Therefore, option A is the correct answer.
4. Ans. C.

- 1) P sits third to the right of O.

Case 1



Case 2



- 2) Three people sit between M and O.
- 3) M is not sitting at an end.

Case 1



Case 2



- 4) N sits second to the right of M.
 - 5) Immediate neighbors of P face the opposite directions.
 - 6) N is not facing the south direction.
- (Here, case 2 will be eliminated and we will continue with the case 1)

Case 1

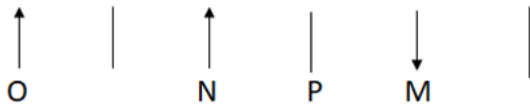

Case 2

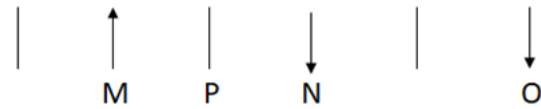

- 7) R is not sitting at an end.
- 8) Q and M face the opposite directions.
- 9) R and Q face opposite directions.
- 10) P and Q face the same direction.

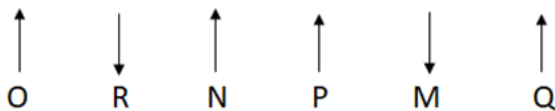

Therefore, option C is the correct answer.

5. Ans. D.

- 1) P sits third to the right of O.

Case 1



Case 2



- 2) Three people sit between M and O.
- 3) M is not sitting at an end.

Case 1



Case 2



- 4) N sits second to the right of M.
 - 5) Immediate neighbors of P face the opposite directions.
 - 6) N is not facing the south direction.
- (Here, case 2 will be eliminated and we will continue with the case 1)

Case 1

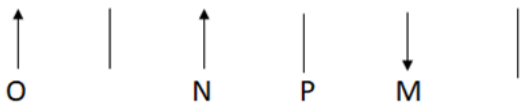

Case 2



- 7) R is not sitting at an end.
- 8) Q and M face the opposite directions.
- 9) R and Q face opposite directions.
- 10) P and Q face the same direction.

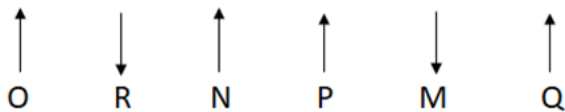

M faces in the south direction.
Therefore, option D is the correct answer

6. Ans. D.

- 1. L sits second to the left of P.
- 2. U sits opposite L.

Case 1

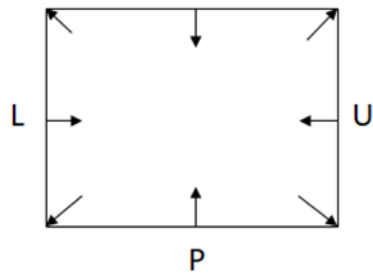

Case 2

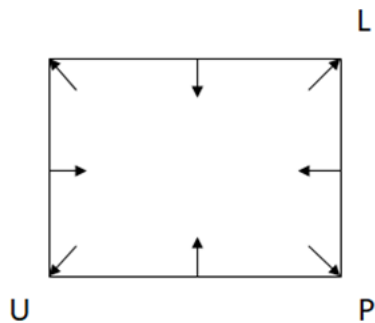

3. One person sits between H and U.
 4. W sits third to the right of H.
 5. O sits opposite G.
 6. R does not face outside.
- (Here, case 1 will be eliminated and we will continue with the case 2)

Case 1

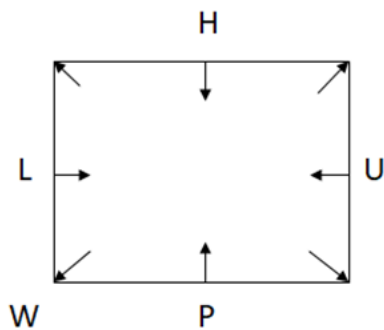

Case 2

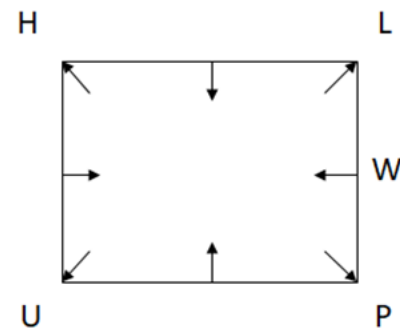

7. P is not a neighbor of G.
- (Refer point 5)

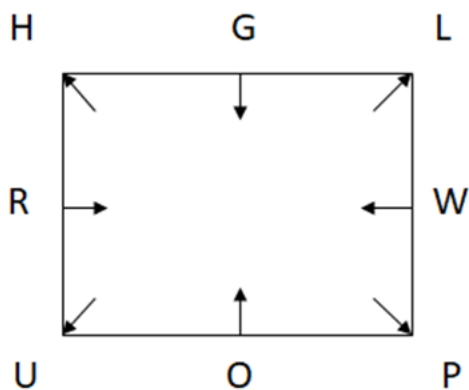

Hence, the required answer is 'W'.

7. Ans. C.

- 1. L sits second to the left of P.
- 2. U sits opposite L.

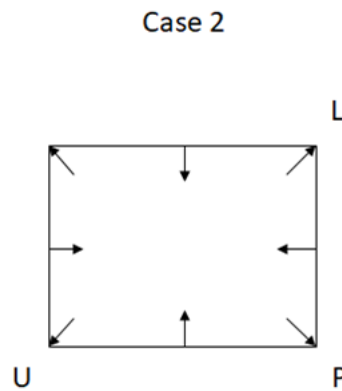
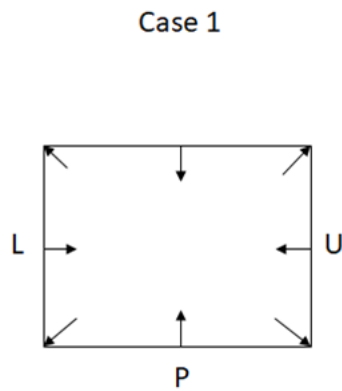

- 3. One person sits between H and U.
 - 4. W sits third to the right of H.
 - 5. O sits opposite G.
 - 6. R does not face outside.
- (Here, case 1 will be eliminated and we will continue with the case 2)

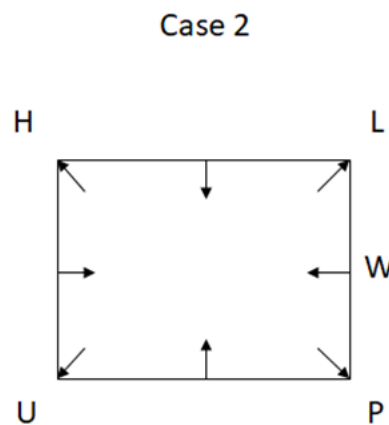
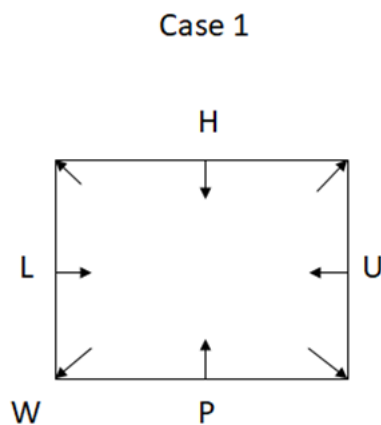

- 7. P is not a neighbor of G.
- (Refer point 5)

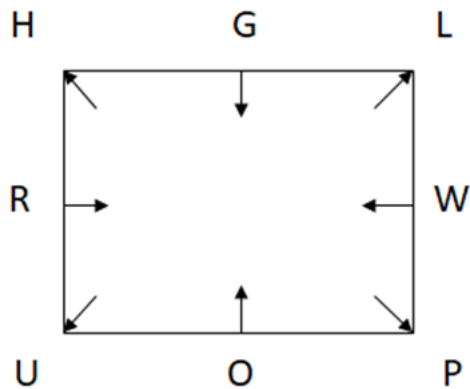

Hence, the required answer is 'O'.

8. Ans. D.

1. L sits second to the left of P.
2. U sits opposite L.

Case 1

Case 2

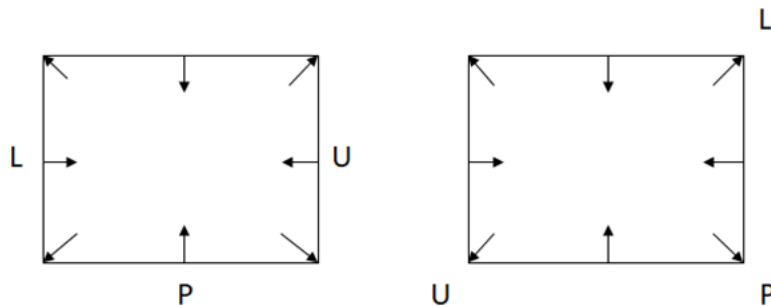

3. One person sits between H and U.
4. W sits third to the right of H.
5. O sits opposite G.
6. R does not face outside.

(Here, case 1 will be eliminated and we will continue with the case 2)

Case 1

Case 2

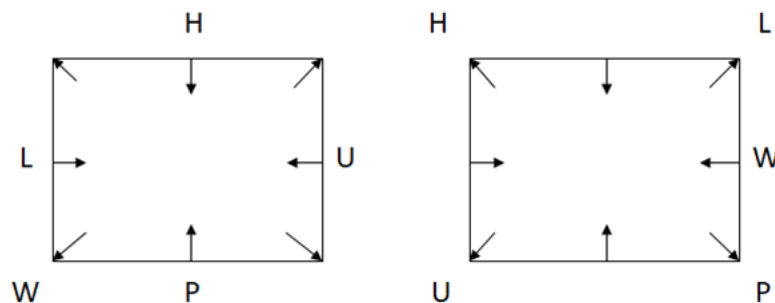

7. P is not a neighbor of G.



SBI Clerk 2022

A Complete Course (Batch-8) (Hindi)

Clear the SBI Clerk Exam in First Attempt

START FREE TRIAL

(Refer point 5)

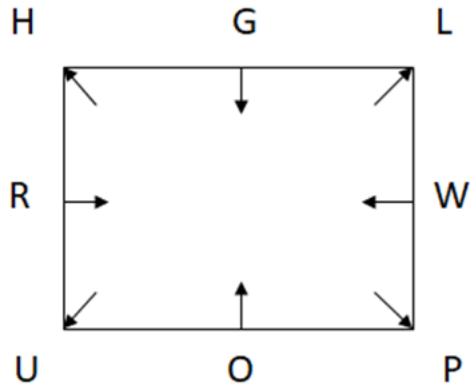

Hence, the required answer is 'Second to the right'.

9. Ans. E.

1. L sits second to the left of P.
2. U sits opposite L.

Case 1

Case 2

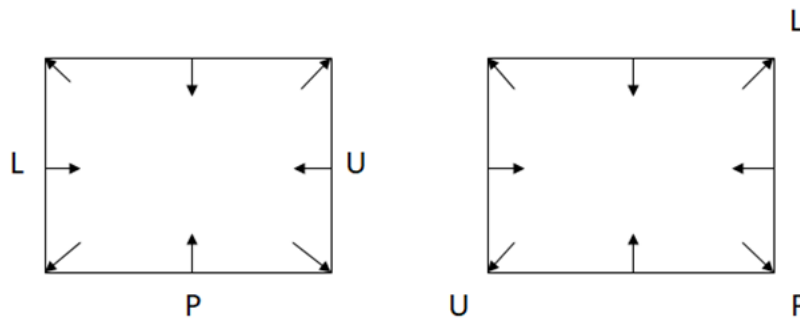



3. One person sits between H and U.
4. W sits third to the right of H.
5. O sits opposite G.
6. R does not face outside.

(Here, case 1 will be eliminated and we will continue with the case 2)

Case 1

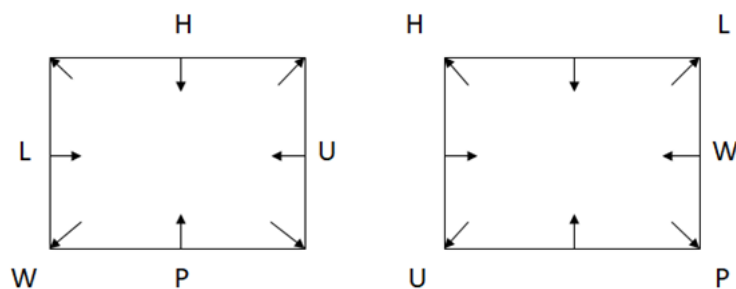
Case 2





SBI Clerk 2022

A Complete Course (Batch-8) (Hindi)

Clear the SBI Clerk Exam in First Attempt

START FREE TRIAL

7. P is not a neighbor of G.
(Refer point 5)

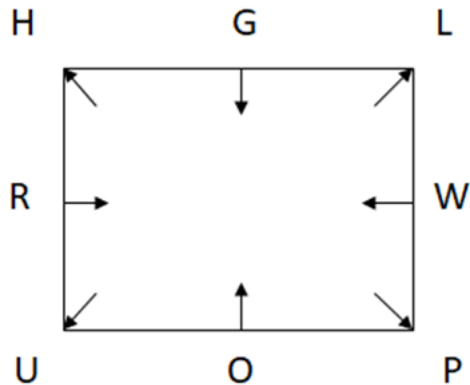

Hence, all are correct.

10. Ans. E.

1. L sits second to the left of P.
2. U sits opposite L.

Case 1

Case 2

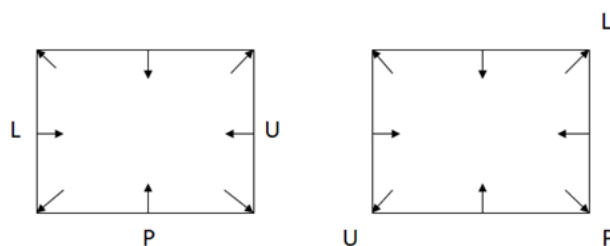

3. One person sits between H and U.
4. W sits third to the right of H.
5. O sits opposite G.
6. R does not face outside.

(Here, case 1 will be eliminated and we will continue with the case 2)

Case 1

Case 2

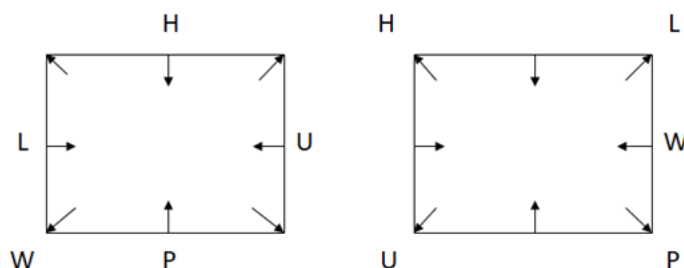

7. P is not a neighbor of G.
(Refer point 5)

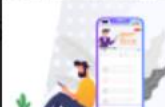

SBI Clerk 2022

A Complete Course (Batch-8) (Hindi)

Clear the SBI Clerk Exam in First Attempt

START FREE TRIAL

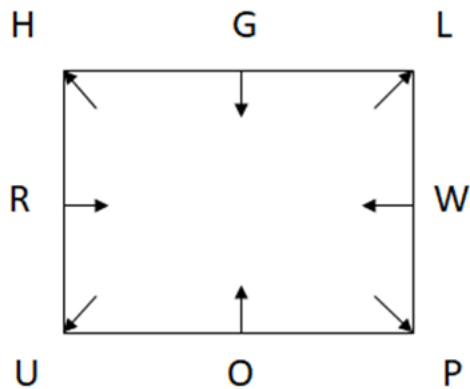

L and O face the opposite directions.

11. Ans. C.

- 1) Three people sit between J and R.
- 2) One person sits between G and R.
- 3) More than one person sits between J and G.

Case 1

Case 2

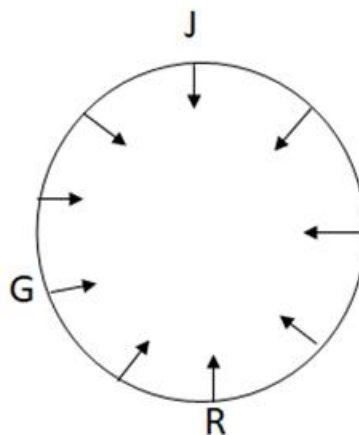
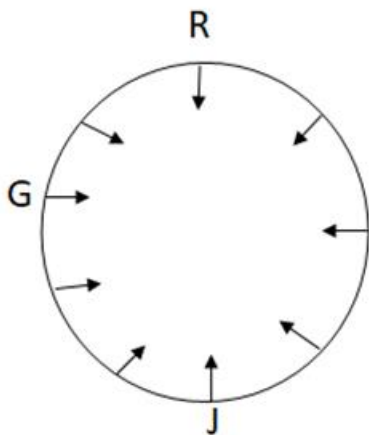

4) N sits second to the right of G.

(Here, case 2 will be eliminated and we will continue with the case 1)

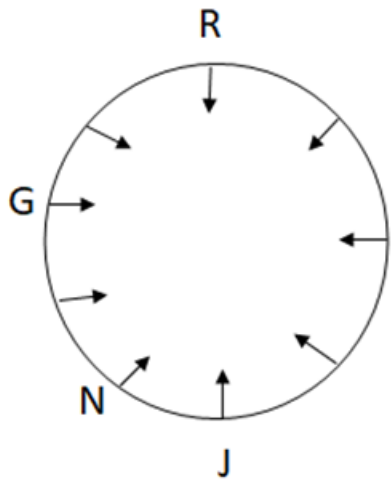

- 5) L is an immediate neighbor of J.
- 6) One person sits between T and L.
- 7) One person sits between P and O, who is not an immediate neighbor of N.
- 8) Z is not sitting immediate right of T.

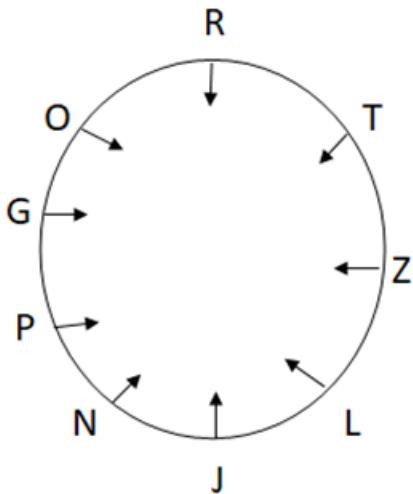

Therefore, option C is the correct answer.

12. Ans. D.

- 1) Three people sit between J and R.
- 2) One person sits between G and R.
- 3) More than one person sits between J and G.

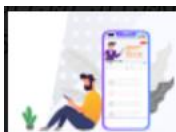

Case 1

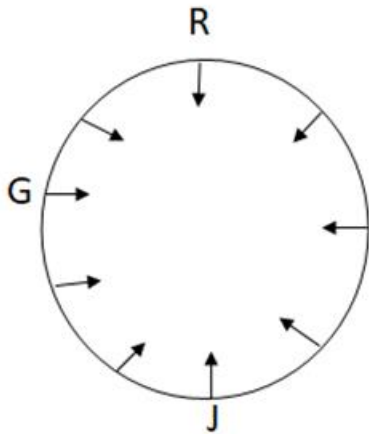

Case 2

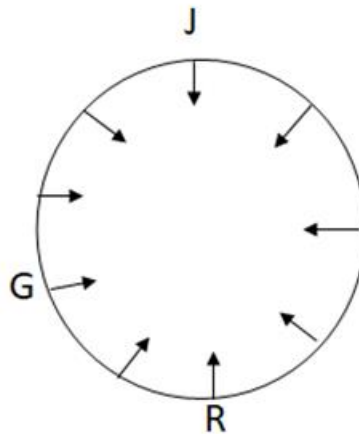

- 4) N sits second to the right of G.
(Here, case 2 will be eliminated and we will continue with the case 1)

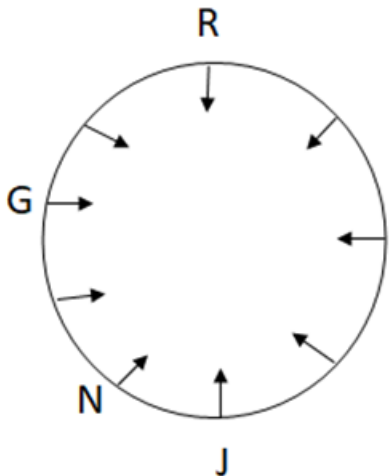

- 5) L is an immediate neighbor of J.
6) One person sits between T and L.
7) One person sits between P and O, who is not an immediate neighbor of N.
8) Z is not sitting immediate right of T.

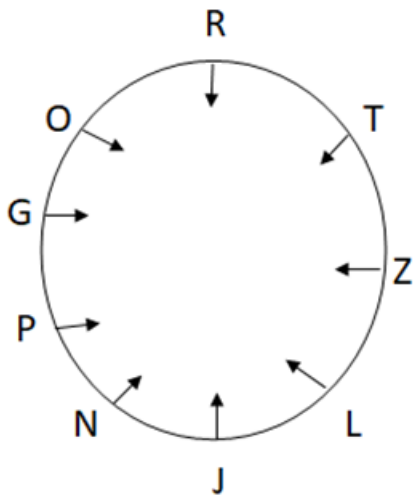

Therefore, option D is the correct answer.

13. Ans. B.

- 1) Three people sit between J and R.
- 2) One person sits between G and R.
- 3) More than one person sits between J and G.

Case 1

Case 2

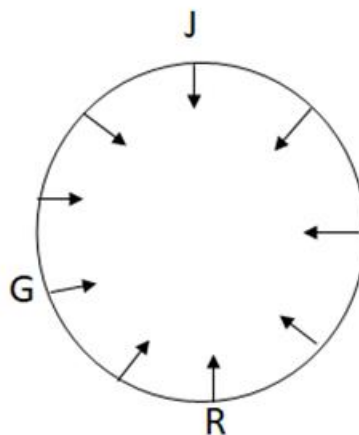
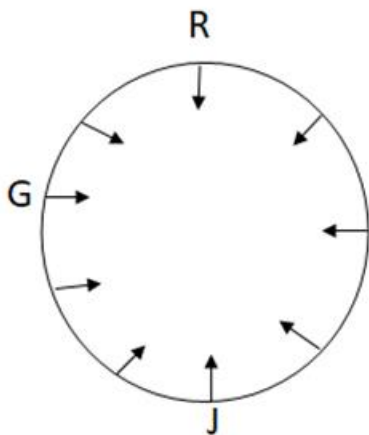

4) N sits second to the right of G.

(Here, case 2 will be eliminated and we will continue with the case 1)

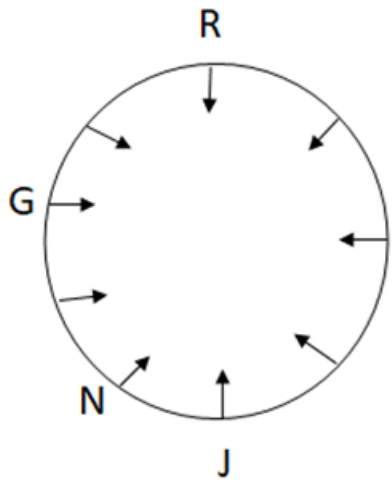

- 5) L is an immediate neighbor of J.
- 6) One person sits between T and L.
- 7) One person sits between P and O, who is not an immediate neighbor of N.
- 8) Z is not sitting immediate right of T.

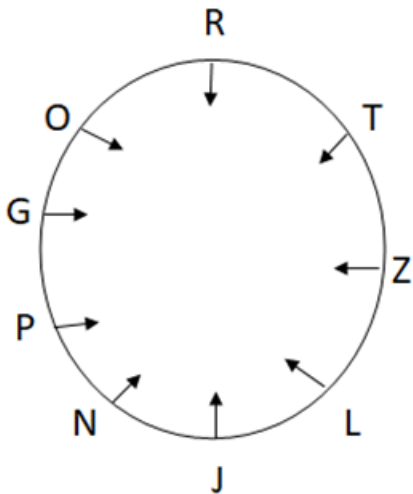

Therefore, option B is the correct answer.

14. Ans. C.

- 1) Three people sit between J and R.
- 2) One person sits between G and R.
- 3) More than one person sits between J and G.

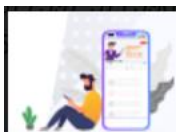

Case 1

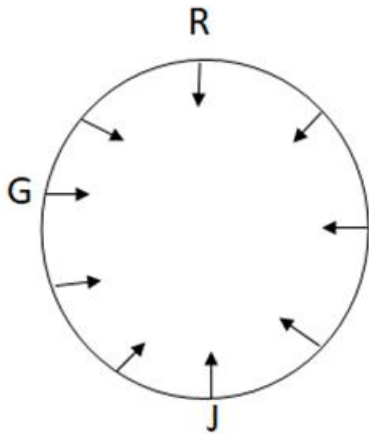

Case 2

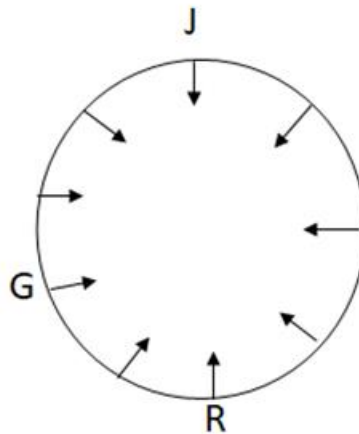

- 4) N sits second to the right of G.
(Here, case 2 will be eliminated and we will continue with the case 1)

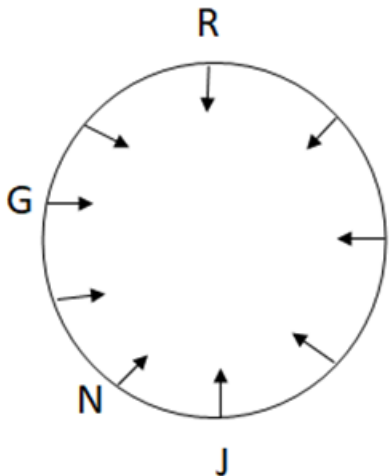

- 5) L is an immediate neighbor of J.
6) One person sits between T and L.
7) One person sits between P and O, who is not an immediate neighbor of N.
8) Z is not sitting immediate right of T.

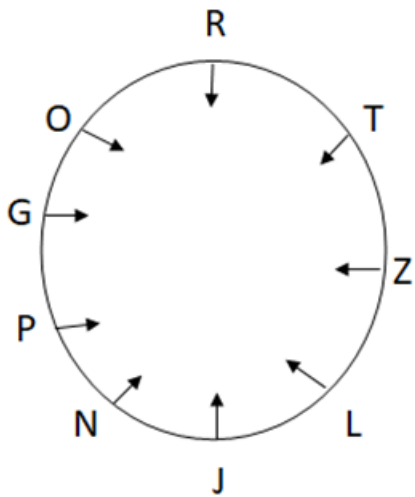

Therefore, option C is the correct answer.

15. Ans. B.

- 1) Three people sit between J and R.
- 2) One person sits between G and R.
- 3) More than one person sits between J and G.

Case 1

Case 2

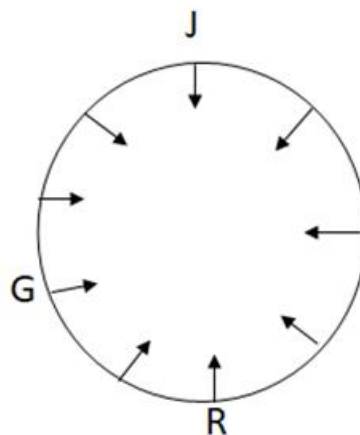
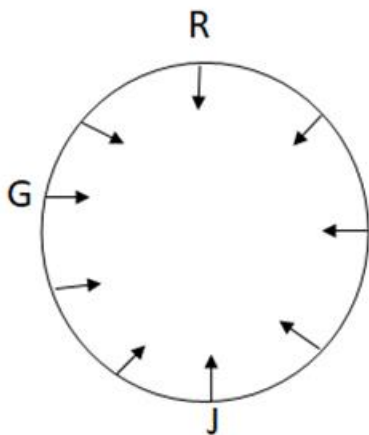

4) N sits second to the right of G.

(Here, case 2 will be eliminated and we will continue with the case 1)

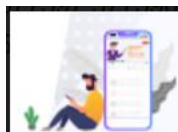

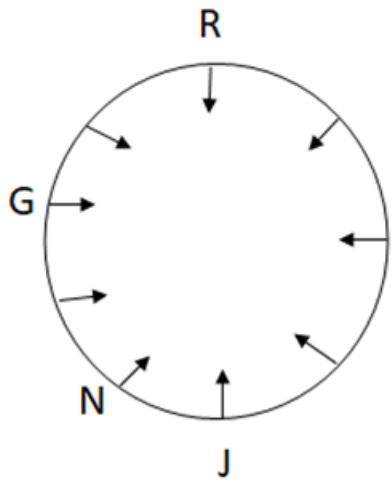

- 5) L is an immediate neighbor of J.
- 6) One person sits between T and L.
- 7) One person sits between P and O, who is not an immediate neighbor of N.
- 8) Z is not sitting immediate right of T.

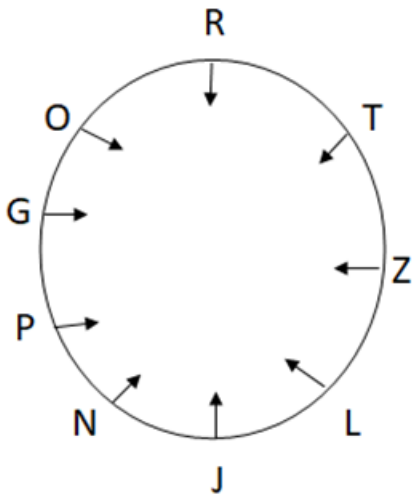

Therefore, option B is the correct answer.

