

Most Expected Questions For SIDBI Grade A Exam 2022

DOWNLOAD PDF



Direction: Study the following information and answer the given questions.

Five people P, Q, R, S, and T are seated around a Pentagonal table, with one seating at the corners, facing inside the table. They have different brands of laptops viz. Acer, Apple, Dell, HP, and Lenovo of different colours viz. Black, Blue, Platinum, Silver, and Red, but not necessarily in the same order.

P has an Acer laptop of neither Blue nor Red. R sits immediately left of T, neither adjacent to P. T has a laptop of neither Lenovo nor HP. The person having a Red laptop sits second to the right of the one having a Platinum laptop. The Platinum laptop does not belong to S. The Red laptop does not belong to R. S owns neither Dell nor HP laptops. The owner of the Lenovo laptop which is Blue is adjacent to T who does not own a Red laptop. P does not own a Silver laptop.

1. How many persons are seated between the persons having Red and Blue when counted anti-clockwise from the Red laptop owner?

- A. No one
- B. One
- C. Three
- D. Five
- E. Four

2. Which colour of laptop S owns?

- A. Black
- B. Red
- C. Silver
- D. Platinum
- E. None of the above

3. Who among the following is not an immediate neighbour of R?

- A. P
- B. T
- C. Q
- D. Both P and Q
- E. Both P and T

4. Q has _____ laptop.

- A. HP
- B. Dell
- C. Lenovo
- D. Apple
- E. None of the above

5. R sits _____ to the left of _____ coloured laptop owner.

- A. 1st, Red
- B. 2nd, Platinum
- C. 3rd, Black
- D. 4th, Silver
- E. None of the above

Direction: Study the data carefully and answer the questions accordingly.

There are eight members in a family with three generations and three married couples. Q is the mother-in-law of U. W is the sister of T, who is the nephew of S. V is the granddaughter of R. T is the



SBI & IBPS 2022: A Sure Shot Success batch
(Batch 5)
Clear All SBI & IBPS 2022 Exams in First Attempt

START FREE TRIAL

brother-in-law of M. U is not married to W. U is a married woman. There are more than three male members. S is not the sibling of Q. M has no child.

6. How M is related to R?

- A. Grandson
- B. Son
- C. Nephew
- D. Son-in-law
- E. None of these

7. How S is related to T?

- A. Brother
- B. Aunt
- C. Daughter
- D. Uncle
- E. None of these

8. Four from the following are similar in a certain way and forms a group. Find out the one, which does not belong to that group.

- A. M
- B. S
- C. T
- D. R
- E. V

Direction: Study the digit-letter sequence carefully and answer the questions given below:

T 1 Y V A 9 B N 2 L P O 5 K W 4 Z D
F C 6 G U 3 H 7 J E 8 M

9. Which amongst the following element is tenth to the right of eighteenth element from the left end?

- A. 7
- B. E
- C. 8
- D. J
- E. None of these

10. How many numbers are there which are immediately preceded by a vowel and immediately followed by a consonant?

- A. Three
- B. Four
- C. Two
- D. Five
- E. None of these

11. If all the odd numbers are removed from the given series then which amongst the following element is seventeenth element from the left end?

- A. F
- B. 6
- C. C
- D. G
- E. None of these

12. If last ten elements are removed from the given series then which amongst the following is eleventh from the right end?

- A. 2
- B. P
- C. L
- D. O
- E. None of these



SBI & IBPS 2022: A Sure Shot Success batch
(Batch 5)
Clear All SBI & IBPS 2022 Exams in First Attempt

START FREE TRIAL

13. How many numbers are there between the fifth element from the right end and ninth element from the left end?

- A. Five
- B. Four
- C. Six
- D. Three
- E. None of these

Direction: Study the following information carefully and answer the following question.

Eight people i.e., A, B, C, D, E, F, G, and H born on the 2nd and 13th of four different months i.e., February, March, June, July. All the information is not necessarily in the same order.

H was born on an even-numbered date in the month having less than 31 days. The number of people who were born after H is one more than before A. Three people were born between A and G. One person was born between A and C. Three people were born between F and E. E was born in the same month as G. Only one person was born between E and B. B and H was not born in the same month.

14. Which amongst the following person was born on 2nd June?

- A. B
- B. G
- C. E
- D. C
- E. None of these

15. Which amongst the following pair born in the same date?

- A. E-H
- B. A-F
- C. H-G
- D. C-B
- E. None of these

16. How many people were born before G?

- A. Two
- B. One
- C. Three
- D. None
- E. More than three

17. D was born in which date?

- A. 2nd July
- B. 13th February
- C. 13th July
- D. 2nd February
- E. None of these

18. Find the odd one?

- A. F-B
- B. A-C
- C. E-B
- D. H-G
- E. D-A

Direction: In each question below, some statements are given followed by some conclusions. You have to take the given statements to be true even if they seem to be at variance with commonly known facts. Read all the conclusions and then decide which of the given conclusions logically follows/follow from the given statements, disregarding commonly known facts.



19. Statements:

No rings are barred.
Only a few calls are barred.
Only a few barred are missed.

Conclusions:

- I. All calls being missed is a possibility.
II. Some missed are not calls.
A. If only conclusion I follows.
B. If only conclusion II follows.
C. If either conclusion I or II follows.
D. If neither conclusion I nor II follows.
E. If both conclusions I and II follow.

20. Statements:

No rings are barred.
Only a few calls are barred.
Only a few barred are missed.

Conclusions:

- I. Some calls which are barred being missed is a possibility.
II. All rings are missed.
A. If only conclusion I follows.
B. If only conclusion II follows.
C. If either conclusion I or II follows.
D. If neither conclusion I nor II follows.
E. If both conclusions I and II follow.

21. Statements:

All talks are motive.
Only a few brains are rough.
No motive are rough.

Conclusions:

- I. Some brains are not motive.
II. All brains being rough is a possibility.

- A. If only conclusion I follows.
B. If only conclusion II follows.
C. If either conclusion I or II follows.
D. If neither conclusion I nor II follows.
E. If both conclusions I and II follow.

22. Statements:

All talks are motive.
Only a few brains are rough.
No motive are rough.

Conclusions:

- I. All brains are talks.
II. Some talks are rough.
III. All motive being brains is a possibility.
A. Only I follows
B. Only I and II follows
C. Only III follows
D. Either I or III follows
E. All of these follows

23. If a meaningful word can be formed using 2nd and 3rd letters of AMAZING and 5th and 6th letters of NATURE, what will be the first letter of the newly formed word? If more than one words can be formed, mark your answer as X. If no meaningful word can be formed, mark your answer as Z.

- A. E
B. R
C. M
D. X
E. Z



Direction: Study the following data carefully and answer the questions accordingly.

Goli starts walking from point B, walks 40m towards the east direction to reach point J. Then, he starts walking in the north direction for 30m to reach point Z. Now, he takes a right turn and walks for 60m to reach point U. Finally, he starts walking in the south direction for 24m to reach point X.

24. Point U is in which direction of point J?

- A. South
- B. North-East
- C. South-West
- D. West
- E. None of these

25. What is the shortest distance between X and J?

- A. $7\sqrt{91}$ m
- B. 40m
- C. $6\sqrt{101}$ m
- D. 47m
- E. None of these

26. If point Q is 30m north of point B then what is the distance between U and Q?

- A. 90m
- B. 120m
- C. 115m
- D. 100m
- E. None of these

Direction: Study the following information carefully and answer the questions given below.

Nine boxes of all of the different shapes – Circle, Square, Rectangle, Triangle, Pentagon, Trapezium, Hexagon, Octagon, and Oval are placed one above another. Each box has a number written on it from 1 to 9 but not necessarily in the same order. Number 1 is at the bottom and number 9 is at the top and others accordingly.

There is at most one box between the triangle box and the oval box. The pentagon box is immediately below the Hexagon box. The rectangle box is below the square box. The circle box is placed at the topmost position. The trapezium box is immediately below the oval box. Two boxes are placed between Circle box and the triangle box. The square box and rectangle box have six boxes in between them.

27. Which of the following statements is true?

- A. Number 7 is written on the oval box.
- B. Three boxes are placed between the square and pentagon box.
- C. Octagon box is placed at the bottommost position.
- D. Two boxes between the box on which number 3 is written and oval box.
- E. None of these



28. Which of the following pairs is correctly matched?

- A. Oval, 8
- B. Square, 7
- C. Rectangle, 2
- D. Trapezium, 3
- E. None of these

29. Which of the following numbers is written on the octagon box?

- A. 1
- B. 3
- C. 5
- D. 7
- E. 6

30. What is the shape of the box on which number 2 is written?

- A. Hexagon
- B. Pentagon
- C. Oval
- D. Octagon
- E. Rectangle

31. What is the shape of the box on which number 4 is written?

- A. Trapezium
- B. Square
- C. Octagon
- D. Hexagon
- E. Cannot be determined

32. In a class of 90 students, Prakash, who is a boy is ranked 13th from the top. If there are five girls ahead of Prakash, in the class, number of boys is twice the number of girls. Now find out how many boys are after him in the class?

- A. 48
- B. 58

- C. 52
- D. 50
- E. None of the above

Direction: In the question below, there is a statement followed by two conclusions numbered I and II. You have to assume everything in the statement to be true. Then consider the two conclusions together and decide which of them follows beyond a reasonable doubt from the information given in the statement.

33. **Statement:**

The quality and pace of course correction on the GST in the coming months will determine if India can hold its 100th position or move up further.

Conclusions:

- I. GST is a flop
- II. GST is a hit
- A. Only conclusion I follows
- B. Only conclusion II follows
- C. Both conclusion I and II follows
- D. Neither conclusion I nor II follows
- E. Either conclusion I or II follows

Direction: In each question below is given a statement followed by two assumptions numbered I and II. An assumption is something supposed or taken for granted. You have to consider the following assumption and decide which of the assumption is implicit in the statement.

34. **Statement:**

Jet Airways has in the last two months trimmed its fleet by 28 planes and will ground about a dozen more aircraft in March mainly



SBI & IBPS 2022: A Sure Shot Success batch
(Batch 5)
Clear All SBI & IBPS 2022 Exams in First Attempt

START FREE TRIAL

due to non-payment of rentals. Eight ATR turboprop jets, a Boeing 737 Max recently included into the fleet, a Boeing 777 and an Airbus A330 plane, and at least seven Boeing 737 NG planes are among the 40 odd aircraft that have been or are in the process of being taken off the fleet. Earlier, Jet had a fleet of 123 planes, which means it will have cut its fleet by close to a third by April.

Assumptions:

I. The airline has undertaken certain proactive adjustments to its flight schedule and is keeping its guests informed of these interim changes, offering them alternate choices, including re-accommodation on the airline's alternate flights, in line with applicable guidelines.

II. The systematic trimming of the fleet has impacted Jet's operations as the airline struggles to get approvals for a resolution plan from various stakeholders.

- A. Both I and II are implicit
- B. Either I or II is implicit
- C. None is implicit
- D. Only II is implicit
- E. Only I is implicit

Direction: In the question below a statement followed by two courses of actions. On the basis of information given in the statement, you have to assume everything in the statement is true then decide which of the suggested course of action is worth pursuing.

35. Statement:

It is obligatory to embrace suitable measures to prevent a repetition of bad debts by learning from the past experiences of mounting non-performing assets of the bank.

Courses of actions:

I. Before granting loans to customers, their eligibility for loans should be assessed strictly.

II. To ensure the payment of installations of loan, the work, for which the loan was sanctioned, should be administered minutely on regular basis.

Of these:

- A. Only I follows
- B. Only II follows
- C. Either I or II follows
- D. Neither I nor II follows
- E. Both I and II follow

Direction: Study the data carefully and answer the questions accordingly.

A certain number of people are sitting in a row. Some of them are facing north and some are facing south direction. Q sits fourth to the right of G, who sits third from an end. Five people sit between Q and R, who sits second to the left of P. M sits fourth to the right of P. Seven people sit between N and M. N and P face the opposite direction. At most eleven people sit to the right of N. Five people sit between N and S, who sits fourth from an end. S faces the north direction. J sits fifth



SBI & IBPS 2022: A Sure Shot Success batch
(Batch 5)
Clear All SBI & IBPS 2022 Exams in First Attempt

START FREE TRIAL

to the right of S. R and J (both face the opposite directions) are not sitting to the right of M. M and Q (who is not sitting to the right of J) face the opposite directions.

36. How many people sit to the right of Q?

- A. Five
- B. Six
- C. Eight
- D. Nine
- E. None of these

37. What is the position of J with respect to P?

- A. Fifth to the right
- B. Fourth to the right
- C. Second to the left
- D. Third to the left
- E. None of these

38. How many people are sitting in this arrangement?

- A. 17
- B. 18
- C. 21
- D. 20
- E. None of these

39. Who among the following sits between J and Q?

- A. R
- B. M
- C. N
- D. S
- E. None of these

40. Four from the following are similar in a certain way and forms a group. Find out the one, which does not belong to that group.

- A. M, S
- B. N, J
- C. G, R
- D. M, N
- E. S, R

Direction: The following Line-graph shows the Profit percentage of 5 different companies for 3 different years. Study the Line-graph and answer the questions based on it.



$$\text{Profit} = \text{Income} - \text{Expenditure}$$
$$\text{Profit \%} = \frac{\text{Income} - \text{Expenditure}}{\text{Expenditure}} \times 100$$

41. The Income of Company C in 2019 was 56 Lakh then what was its Expenditure in 2019 ?

- A. 40 Lakh
- B. 78.4 Lakh
- C. 58 Lakh
- D. 56 Lakh
- E. 42 Lakh



SBI & IBPS 2022: A Sure Shot Success batch
(Batch 5)
Clear All SBI & IBPS 2022 Exams in First Attempt

START FREE TRIAL

42. The Expenditure of Company A in 2018 is 35 Lakh then what was its Income in the same year ?

- A. 35 Lakh
- B. 81 Lakh
- C. 42.5 Lakh
- D. 50.75 Lakh
- E. 37.5 Lakh

43. The sum of Income of Company A, B, C in the year 2018 was 72 Lakh then find the sum of their Expenditure in the same year?

- A. 72 Lakh
- B. 90 Lakh
- C. 1.08 crore
- D. 54.5 Lakh
- E. Can't be determined

44. The Income of Company A in 2019 is 55 Lakh, then find its Profit in this year?

- A. 12 Lakh
- B. 9.875 Lakh
- C. 19.25 Lakh
- D. 14.26 Lakh
- E. 17.35 Lakh

45. If the Expenditure of Company D in 2018 & 2019 is equal then find the ratio of Income of Company D in 2018 & 2019 ?

- A. 29 : 37
- B. 30 : 31
- C. 21 : 29
- D. 43 : 53
- E. 52 : 69

Direction: What will come in the place of the question mark (?) in the following number series?

46. 100, 102, 310, 1556, ?, 98110

- A. 11700
- B. 11900
- C. 10600
- D. 10900
- E. None of these

Direction: What will come in place of the question mark (?) in the following number series?

47. 14, 70, 98, 112, 119, ?

- A. 122.5
- B. 121.5
- C. 112.5
- D. 124
- E. None of these

Direction: What will come in the place of the question mark (?) in the following number series?

48. 2, 18, 82, 338, 1362, ?

- A. 5488
- B. 5478
- C. 5258
- D. 5338
- E. 5458

Direction: What should come in place of the question mark ('?') in the following number series?

49. 6, 22, 46, 78, 118, ?

- A. 165
- B. 166
- C. 167
- D. 168
- E. 169



SBI & IBPS 2022: A Sure Shot Success batch
(Batch 5)
Clear All SBI & IBPS 2022 Exams in First Attempt

START FREE TRIAL

Direction: What should come in place of the question mark ('?') in the following number series?

50. 9.5, 47.5, 213.75, ?, 2992.5, 8977.5, 22443.75

- A. 855
- B. 755
- C. 852
- D. 853
- E. 854

Direction: In the following question two equations are given in variables x and y . You have to solve these equations and determine the relation between x and y .

51. I. $2x^2 - 5x + 2 = 0$

II. $3y^2 + 28y + 9 = 0$

- A. $x > y$
- B. $x < y$
- C. $x \leq y$
- D. $x \geq y$

E. $x = y$ or no relation can be established

Direction: In the following question two equations are given in variables x and y . You have to solve these equations and determine the relation between x and y .

52. I. $x^2 - 8x + \sqrt{144} = 0$

II. $2y^2 - 21y = 3y$

- A. if $x > y$
- B. if $x \leq y$
- C. if $x < y$
- D. if $x \geq y$
- E. if $x = y$ or relationship between x and y can't be established

Direction: In the following question two equations are given in variables X and Y . You have to solve these equations and determine the relation between X and Y .

53. I. $14X^2 + 6X = 3x + 2$

II. $5Y^2 + 8Y = 6Y + 3$

- A. $X > Y$
- B. $X < Y$
- C. $X \leq Y$
- D. $X \geq Y$
- E. $X = Y$ or no relation can be established

54. I. $8X^2 + \frac{1}{4} = \frac{12X}{4}$

II. $9Y^2 - 6Y + 1 = 0$

- A. $X > Y$
- B. $X < Y$
- C. $X \leq Y$
- D. $X \geq Y$
- E. $X = Y$ or no relation can be established

55.

I. $x^2 - 27x + 162 = 0$

II. $y^2 - 43y + 450 = 0$

- A. if $x > y$
- B. if $x \leq y$
- C. if $x < y$
- D. if $x \geq y$
- E. if $x = y$ or relationship between x and y can't be established

56. In 2018, number of males in the village are 50% more than the number of females in it. Male population of the village increases by 25% every year while the female population of the village decreases by 20% every year. Population of



SBI & IBPS 2022: A Sure Shot Success batch
(Batch 5)
Clear All SBI & IBPS 2022 Exams in First Attempt

START FREE TRIAL

the village in 2020 is how much percent less/more than the population of the village in 2018?

- A. 19.35% more
- B. 10.25% less
- C. 21.25% more
- D. 15.5% less
- E. 12.5% more

57. In a business Anmol invests $\frac{2}{3}$ of the capital for $\frac{1}{3}$ of the time, Sneha

invests $\frac{1}{4}$ of the capital for $\frac{2}{3}$ of time and Chirag invests the remaining capital for full time. Find the sneha's share if the total profit is Rs. 3060.

- A. Rs. 1080
- B. Rs. 1280
- C. Rs. 800
- D. Rs. 680
- E. none of these

58. A group of friends travelled a certain distance upstream in a boat in 4 hours. If the downstream speed is one and half times the upstream speed of boat then find the time taken to cover the same distance when boat is moving just because of stream?

- A. 15 h
- B. 12 h
- C. 16 h
- D. 18 h
- E. None of the above

59. Cost prices of a mobile and an earphone are same. The shopkeeper marked the mobile and the earphone 60% and 50%

respectively above their cost prices. The mobile is sold after a discount of 25% while the earphone is sold after a discount of 30%. Find the cost price of the mobile if the total profit earned after selling the mobile and earphone is Rs. 2500

- A. Rs. 10000
- B. Rs. 8000
- C. Rs. 6000
- D. Rs. 12000
- E. Rs. 14000

60. 10 men or 25 women can do a piece of work in 12 days. 'x' men and 'x + 8' women started the work and the work got completed in 20 days. Find the number of women who started the work.

- A. 10
- B. 8
- C. 12
- D. 11
- E. None of these

Direction: What approximate value will come in place of the question mark (?) in the following question? (You are not expected to calculate the exact value)

$$61. 15 \times (?)^3 + (14.96)^2 = (39.94)^2 - 399.86$$

- A. 5
- B. 4
- C. 3
- D. 6
- E. 9



SBI & IBPS 2022: A Sure Shot Success batch
(Batch 5)
Clear All SBI & IBPS 2022 Exams in First Attempt

START FREE TRIAL

Direction: What approximate value will come in place of the question mark(?) in the following questions. (You are not expected to calculate the exact value) ###DONE###

62. $\frac{1039.852}{?} - 1339.93 = 19.89\%$ of $900.03 - 1439.94$

- A. 13
- B. 18
- C. 16
- D. 15
- E. None of these

63. $\frac{49.98 \times \sqrt{7}}{59.97} = 16.02^2 - 8.98^2$

- A. 210
- B. 441
- C. 44100
- D. 4410
- E. None of these

64. $(9.12 \times 6.01 - 4.99 \times 7.89) \times ? = 6.99$

- A. 0.5
- B. 2.5
- C. 3.5
- D. 6.5
- E. 1.5

65. $2729.98 \div 455.02 + \sqrt{960} + ?^2 = \sqrt{5329.05}$

- A. 8
- B. 6
- C. 16
- D. 36
- E. 15

Direction: Study the passage given below and answer the following questions.

Students applied for three posts in the IBPS examination - Probationary officer, specialist officer and clerk. Male students applied for clerk are 3 times the male students applied for P.O. and male students applied for S.O. are 120 more than male student applied for P.O. Ratio of male to female students applied for P.O. is 2: 3 and female students applied for S.O. and clerk are same. Male applied for P.O. are 25% less than female applied for clerk. Total number of students applied for the examination is 1220.

66. Find the total students applied for the post of Clerk.

- A. 520
- B. 540
- C. 420
- D. 560
- E. 460

67. Find the ratio of total male students to total female students applied in the examination.

- A. 31 : 25
- B. 42 : 19
- C. 36 : 25
- D. 36 : 23
- E. None of these



SBI & IBPS 2022: A Sure Shot Success batch
(Batch 5)
Clear All SBI & IBPS 2022 Exams in First Attempt

START FREE TRIAL

68. Total students applied for P.O. are what percent less than total students applied for S.O.?

- A. 15%
- B. 25%
- C. 35%
- D. 10%
- E. 40%

69. Male students applied for P.O. and clerk together are what percent of female students applied for clerk and S.O. together?

- A. 100%
- B. 50%
- C. 125%
- D. 150%
- E. 200%

70. Female students applied for P.O. and S.O. together are how much more or less than male students applied for same posts?

- A. $\frac{25}{9}$ %
- B. $\frac{50}{3}$ %
- C. $\frac{25}{3}$ %
- D. $\frac{50}{9}$ %
- E. None of these

71. Anuj observed that he required 45 seconds less to cross a circular ground along its diameter than to complete one round along its boundary. If his speed was 40 m/min, what is the radius of the circular ground? (take $\pi = \frac{22}{7}$)

- A. 10.25 m
- B. 7 m
- C. 5 m
- D. 4.50 m
- E. 8.25 m

72. There are two mixtures, A and B, of acid and alcohol. In mixture A, the ratio of acid to alcohol is 7 : 5. After adding 18 L of mixture B in which ratio of alcohol to acid is 1 : 2 in the mixture A, the quantity of acid becomes 60% more than that of alcohol in the final mixture. Find the total quantity of acid in the final mixture.

- A. 28 L
- B. 24.4 L
- C. 32.4 L
- D. 28.6 L
- E. 28.8 L

73. The ratio of sum of salaries of Anik and Bhuvan to the difference of their salaries is 9 : 2 and the ratio of sum of the salaries of Bhuvan and Charlie to the difference of their salaries is also 9 : 2. If Anik's salary is the highest and Charlie's the lowest, then what is Bhuvan's salary, given total of their salaries to be Rs. 494000?

- A. Rs. 164000
- B. Rs. 154000
- C. Rs. 200000
- D. Rs. 72000
- E. None of these

74. Two vessels A and B of capacity 100 liters and 270 liters contains mixture of milk and water in the ratio of 3:2 and 5:4. When 30% of the mixture from vessel A is taken out and added to vessel B. After mixing it thoroughly in vessel B 50% of the mixture from vessel B is taken out and added to vessel A



then find the ratio of milk and water in vessel A after the two procedure?

- A. 19:15
- B. 14:17
- C. 63:47
- D. 18:67
- E. 16:89

75. A book consists of 110 pages, 32 lines on each page and 16 characters on each line. If this content is written in another notebook consisting of 44 pages and 20 lines on each page then the required number of character per line will be how much percentage more than the number of characters per line in first book?

- A. 300%
- B. 250%
- C. 100%
- D. 175%
- E. 225%

Direction: Study the following information carefully and answer the given question.

The given below pie chart shows the percentage distribution of population of seven villages of a block in 2006. There are only these 7 villages in block.

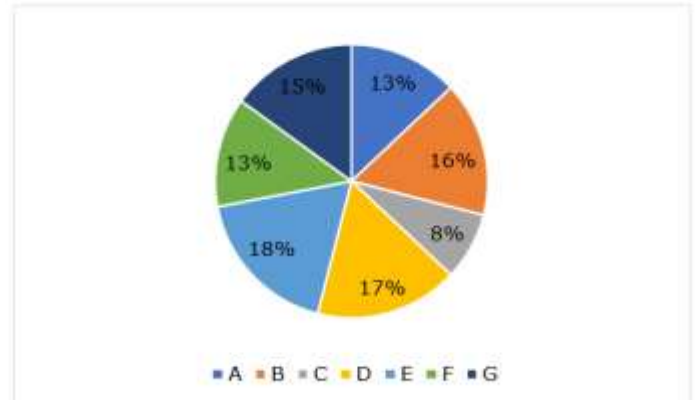

The given below table shows percentage of population below poverty line and ratio of number of males to females in every village.

Village	Percentage of population below poverty line	Ratio of number of males to females
A	45	2 : 3
B	50	1 : 2
C	60	5 : 7
D	40	12 : 13
E	20	7 : 5
F	25	1 : 1
G	30	3 : 5

76. If the total population of all the villages in 2006 is 120 lakhs then find the difference between the number of people who are above poverty line in Villages A and C?

- A. 4.74 lakhs
- B. 5.70 lakhs
- C. 2.87 lakhs
- D. 5.44 lakhs
- E. 6.54 lakhs

77. If the number of people below poverty line in village G is 9 lakhs then find the difference between the number of males and females in village E?



SBI & IBPS 2022: A Sure Shot Success batch
(Batch 5)
Clear All SBI & IBPS 2022 Exams in First Attempt

START FREE TRIAL

- A. 8 lakhs
- B. 10 lakhs
- C. 6 lakhs
- D. 12 lakhs
- E. 5 lakhs

78. The male population of village F in 2007 is 10 lakhs which is 150% more than the male population of village F in 2006 then find the number of people above poverty line in village F in 2006?

- A. 17 lakhs
- B. 12 lakhs
- C. 16 lakhs
- D. 6 lakhs
- E. None of these

79. If the total population of village B and D is 99 lakhs then find the difference between the female population of village A and male population of village C.

- A. 5.8 lakhs
- B. 15.5 lakhs
- C. 13.4 lakhs
- D. 2.12 lakhs
- E. 12.9 lakhs

80. If the number of people below poverty line in village G is 18 lakhs then find the difference between the male population of village E and female population of village E?

- A. 40 lakhs
- B. 30 lakhs
- C. 20 lakhs
- D. 12 lakhs
- E. 18 lakhs

Direction: Read the following passage carefully and the questions given below it. Certain words/phrases are given in bold to help you locate them while answering some of the questions.

Globalization is entering a new era, defined not only by cross-border flows of goods and capital, but also, and increasingly, by flows of data and information. This shift would seem to favor the advanced economies, whose industries are at the frontier in employing digital technologies in their products and operations. Will developing countries be left behind?

For decades, vying for the world's low-cost manufacturing business seemed to be the most promising way for low-income countries to climb the development ladder. Global trade in goods rose from 13.8% of world GDP in 1985 (\$2 trillion) to 26.6% of GDP (\$16 trillion) in 2007. Propelled by demand and outsourcing from advanced economies, emerging markets won a growing share of the soaring trade in goods; by 2014, they accounted for more than half of global trade flows.

Since the Great Recession, however, growth in global merchandise trade has stalled, mainly owing to anemic demand in the world's major economies and plummeting commodity prices. But



SBI & IBPS 2022: A Sure Shot Success batch
(Batch 5)
Clear All SBI & IBPS 2022 Exams in First Attempt

START FREE TRIAL

deeper structural changes are also playing a role. Many companies are simplifying and shortening their supply chains. For a range of goods, automation means that production location and outsourcing decisions no longer depend primarily on labor costs. Quality of talent, infrastructure, energy costs, and speed to market are assuming greater weight in such decisions. In the near future, 3D printing could further reduce the need to ship goods across long distances.

If trade in global goods has indeed peaked relative to global GDP, it will be harder for poor countries in Africa, Latin America, and Asia to develop by becoming the world's next workshops. But globalization itself is not in retreat. While global goods trade has stalled and cross-border financial flows have fallen sharply since 2007, flows of digital information have surged: Cross-border bandwidth use has grown 45-fold over the past decade, circulating ideas, intellectual content, and innovation around the world.

New research from the McKinsey Global Institute (MGI) finds that cross-border flows of goods, services, finance, people, and data during this period increased world GDP by roughly 10% – roughly an additional \$7.8 trillion in 2014 alone. Data flows accounted for an estimated \$2.8 trillion of this gain,

exerting a larger impact than global goods trade – a remarkable finding, given that the world's trade networks developed over centuries while cross-border data flows were nascent just 15 years ago.

Digitization disrupts everything: the nature of goods changing hands; the universe of potential suppliers and customers; the method of delivery, and the capital and scale required to operate globally. It expands opportunities for more types of firms, individuals, and countries to participate in the global economy. It also gives countries and companies everywhere an opportunity to redefine their comparative and competitive advantage. For example, while the United States may have been at a disadvantage in a world where low labor costs were paramount in global manufacturing value chains, digital globalization plays directly to its strengths in technology and innovation.

On its face, this shift to digital globalization would seem to work against developing countries that have large pools of low-cost labor but inadequate infrastructure and education systems. Advanced economies dominate MGI's latest Connectedness Index, which ranks countries on both inflows and outflows of goods, services, finance, people, and data relative to their size and share in each type of global



SBI & IBPS 2022: A Sure Shot Success batch
(Batch 5)
Clear All SBI & IBPS 2022 Exams in First Attempt

START FREE TRIAL

flow. These flows are disproportionately concentrated among a small set of countries, including the US, the United Kingdom, Germany, and Singapore, with huge gaps between the leaders and **laggards**. China is the only emerging economy to have made it to the top ten on the index.

Yet digital flows offer developing countries new ways of engaging with the global economy. The near-zero marginal costs of digital communications and transactions create new possibilities for conducting cross-border business on a massive scale. Alibaba, Amazon, eBay, Flipkart, and Rakuten are turning millions of small enterprises around the world into “micro-multinational” exporters. Companies based in developing countries can overcome local market constraints and connect with customers, suppliers, financing, and talent worldwide. Twelve percent of global goods trade is already conducted in e-commerce channels.

Moreover, a country need not develop its own Silicon Valley to benefit. Countries on the **periphery**, of the network of global data flows, can benefit more than countries in the center. Digital connections promote productivity growth; indeed, they can help developing economies move to the productivity frontier by exposing

their business sectors to ideas, research, technologies, and best management and operational practices, and by building new channels to serve large global markets.

Source: <https://www.project-syndicate.org>

81. How Countries on the perimeter of the network of global data flow benefits?

- A. Cross-border bandwidth use has grown 45-fold over the past decade, circulating ideas, intellectual content, and innovation around the world
- B. Companies based in developing countries can overcome local market constraints and connect with customers, suppliers, financing, and talent worldwide
- C. Digital connections promote productivity growth and they can help developing economies move to the productivity frontier by exposing their business sectors to ideas, research, technologies, and best management and operational practices by building new channels to serve large global markets
- D. Both A and B
- E. None of the above

82. Which among the following is **TRUE** according to the passage given above?

- A. automation means that production location and outsourcing



SBI & IBPS 2022: A Sure Shot Success batch
(Batch 5)
Clear All SBI & IBPS 2022 Exams in First Attempt

START FREE TRIAL

decisions no longer depend primarily on labor costs.

B. Alibaba, Amazon, eBay, Flipkart, and Rakuten are turning millions of small enterprises around the world into “micro-multinational” exporters.

C. Globalization is entering a new era, defined not only by cross-border flows of goods and capital, but also, and increasingly, by flows of data and information.

D. China is the only emerging economy to have made it to the top ten on the index.

E. All of above

83.What according to the author create new possibilities for conducting cross-border business on a massive scale?

A. The near-zero marginal costs of digital communications and transactions

B. by flows of data and information

C. the nature of goods changing hands; the universe of potential suppliers and customers

D. Both A and C

E. All of the above

84.How according to the passage Digitization disrupts everything?

A. the nature of goods changing hands; the universe of potential suppliers and customers; the method of delivery, and the capital and scale required to operate globally

B. the political backlash against globalization is gaining momentum

in many places even as digitization increases the opportunities and economic benefits that globalization has to offer

C. Digitization gives countries and companies everywhere an opportunity to redefine their comparative and competitive advantage.

D. both A and C

E. All of the above

85.What is the central theme of the passage?

A. New innovations around the world

B. Globalization is entering a new era

C. Twenty- first - century globalization

D. Digital globalization and developing world

E. All of the above

86.Which among the following is MOST SIMILAR in meaning to the word “**periphery**”?

A. mainstream

B. marrow

C. boundary

D. intermediacy

E. kernel

87.Which among the following is MOST OPPOSITE in meaning to the word “**laggards**”?

A. lingerer

B. loiterer

C. poke

D. procrastinator

E. workaholic



SBI & IBPS 2022: A Sure Shot Success batch
(Batch 5)
Clear All SBI & IBPS 2022 Exams in First Attempt

START FREE TRIAL

Direction: In the following passage, some of the words have been left out, each of which is indicated by a number. Find the suitable word from the options given against each number and fill up the blanks with appropriate words to make the paragraph meaningfully complete.

The coronavirus is a serious and largely **(###Q1###)** situation, one not to be taken lightly. Yet, amid the swirling vortex of uncertainty, you can't help but gawp in wonderment at how a stockpile of toilet rolls has become the new status symbol.

Hand sanitiser is a **(###Q2###)** being traded like gold. Common sense is often nowhere to be found. Think of the millions of merchandise items – aprons, keyrings, mugs and coasters – bearing the slogan, "Keep Calm and Carry On", that have been sold in recent years. This **(###Q3###)** did not age well. Keep Calm and Carry On. No bother. But first, just let me pop to Costco and buy 200 loo rolls.

I do wonder, though, if the folk **(###Q4###)** stockpiling toilet paper have confused coronavirus with norovirus? It's not an item high on my list.

Curiously, while there have been grumbles about **(###Q5###)** soap supplies on some supermarket shelves, this has sparked less of a frenzy than the new national **(###Q6###)** with hand sanitiser. Which doesn't say much for the

general standards of hygiene pre-coronavirus.

The disparaging term "the great unwashed" coined by Victorian writer Edward Bulwer-Lytton could be **(###Q7###)** and repurposed quite literally. As an airport worker wearily lamented: "The number of people who hand you their passport or boarding pass after they have had it in their mouth ..."

88. Find out the appropriate word in each case.

- A. unprecedented
- B. fertile
- C. fatal
- D. ruinous
- E. None of these

89. Find out the appropriate word in each case.

- A. fatigue
- B. commodity
- C. vigorous
- D. exhaustion
- E. None of these

90. Find out the appropriate word in each case.

- A. corrupt
- B. venerable
- C. animus
- D. trend
- E. None of these

91. Find out the appropriate word in each case.

- A. antagonism
- B. enmity
- C. amity
- D. puritanical
- E. None of these



SBI & IBPS 2022: A Sure Shot Success batch
(Batch 5)
Clear All SBI & IBPS 2022 Exams in First Attempt

START FREE TRIAL

92. Find out the appropriate word in each case.

- A. austerity
- B. lenient
- C. behest
- D. dwindling
- E. None of these

93. Find out the appropriate word in each case.

- A. irenic
- B. provocative
- C. dispensation
- D. obsession
- E. None of these

94. Find out the appropriate word in each case.

- A. dusted off
- B. disparate
- C. adduce
- D. lineage
- E. None of these

Direction: The given sentences, (A), (B), (C), (D), (E) and 6, when properly sequenced, form a coherent paragraph. Find the most logical order of the sentences to construct a coherent paragraph, keeping (6) as the last statement. Then answer the questions that follow.

A) In contrast, a scientific article published in the National Medical Journal of India, 2016, indicates prevalence of _____ diseases such as silicosis and byssinosis.

B) During 2011-16, the number of cases of occupational diseases reported to the government in India was only 562.

C) According to the recent estimates released by the International Labour Organization (ILO), 2.78 million workers die every year from occupational accidents and work-related diseases, and 313 million workers suffer from non-fatal occupational accidents and diseases.

D) In India, available government statistics show a decreasing trend in occupational injuries in manufacturing and mining sectors.

E) It means that 7,500 people die every day due to unsafe and unhealthy working conditions.

F) Even in countries with the most well-established data collection systems, underreporting, particularly of non-fatal occupational accidents and especially work-related diseases, is common.

95. Which of the following would be the FIFTH sentence after rearrangement?

- A. A
- B. B
- C. C
- D. D
- E. F

96. Which of the following can precede the FIFTH sentence of the passage?

A. It is critical that India establishes efficient Occupational Safety and



Health (OSH) data collection systems to better understand the situation for effective interventions.

B. India has been strengthening national OSH policy frameworks for providing adequate protection to workers.

C. Caution is needed when interpreting the statistics as unregistered factories and mines are not covered.

D. We must address the safety and health of workers active in the micro and small enterprises, those in the informal economy and in rural and agricultural sectors.

E. None of these

97. Which of the following pairs form two consecutive statements after rearrangement?

A. A-E

B. A-D

C. E-B

D. B-A

E. None of these

98. Which of the following words would fill the blank given in statement A?

A. Non-communicable

B. Susceptible

C. Unusual

D. Occupational

E. None of these

99. Which of the following should be the FOURTH sentence after rearrangement?

A. B

B. C

C. D

D. E

E. F

Direction: Read the following sentences to find out whether there is any error in them. The error, if any, will be in one part of the sentence. The number corresponding to that part will be your answer. If the given sentence is correct, mark your Answer As "No error". Ignore punctuation error if any.

100. After demonetisation, restoring the confidence (1)/ of sole proprietor and small-medium (2)/ sized enterprises is the key (3)/ to revive "animal spirits" in the economy (4).

A. 1

B. 2

C. 3

D. 4

E. No error

Direction: Read the following sentence to find out whether there is any error in it. The error, if any, will be in one part of the sentence. The number corresponding to that part will be your answer. If the given sentence is correct as it is, mark the answer as 'No error'. Ignore the errors of punctuation if any: ###DONE###

101. Beekeeping Initiatives have been (1)/ launched by increase yield and quality (2)/ of crops through pollination, which will



SBI & IBPS 2022: A Sure Shot Success batch
(Batch 5)
Clear All SBI & IBPS 2022 Exams in First Attempt

START FREE TRIAL

also(3)/ provide honey and other beehive products like wax. (4)

- A. 1
- B. 2
- C. 3
- D. 4
- E. No error

Direction: Read the following sentence to find out whether there is any error in it. The error, if any, will be in one part of the sentence. The number corresponding to that part will be your answer. If the given sentence is correct as it is, mark the answer as 'No error'. Ignore the errors of punctuation if any:

102. "The Saras Collection" has been launched (1)/ on the Government e-Marketplace portal by the Union Minister (2)/ for Rural Development Panchayati Raj (3)/ and Agriculture and Farmers' Welfare, Narendra Singh Tomar. (4)

- A. 1
- B. 2
- C. 3
- D. 4
- E. No error

Direction: Read the sentence to find out whether there is any error in it. The error, if any, will be in one part of the sentence. The number corresponding to that part will be your answer. If the given sentence is correct as it is, mark the answer as No error. Ignore the errors of punctuation if any.

103. Black Panther was one of the (1)/ most-awaited Marvel movies and during (2)/ its theatrical run, it became the (3)/ largest grossing solo superhero film. (4)

- A. 1
- B. 2
- C. 3
- D. 4
- E. No error

Direction: Which of the following phrases (i), (ii), and (iii) given below each sentence should replace the phrase printed in bold letters to make the sentence grammatically correct? Choose the best option among the five given alternatives that reflect the correct use of phrase in the context of the grammatically correct sentence. If the sentence is correct as it is, mark (E) i.e., "No correction required" as the answer.

104. Most of the demonstrations were peaceful, except in the capital **where the police resort to more violent measures.**

- I) where the polices resort to more violent measures
- II) where the police resorting to more violent measures
- III) where the police resorted to more violent measures
- A. Only I
- B. Both II and III
- C. Only III
- D. Both I and III
- E. No correction required



SBI & IBPS 2022: A Sure Shot Success batch
(Batch 5)
Clear All SBI & IBPS 2022 Exams in First Attempt

START FREE TRIAL

105. As the water surged down the river, **it hitting a large hydroelectric power plant** being built by the government.

- I) on hit a larger hydroelectric power plant
- II) it hit a large hydroelectric power plant
- III) it hit an larger hydroelectric power plant
- A. Only I
- B. Both I and II
- C. Both II and III
- D. Only II
- E. No correction required

106. An asphalt road, **set among two arid lawns**, branched south from the university's main entry gate.

- I) setting among two arid lawns
- II) set between two arid lawns
- III) set amidst two arid lawns
- A. Only I
- B. Both I and II
- C. Both II and III
- D. Both I and III
- E. No correction required

Direction: In the given question, a connector is given for the statements I, II and III. Choose the pair of sentences which can be combined using the given connector, when used in the beginning of the new sentence.

107. Primarily

- I) Indian economy earns mostly from agricultural activities.

II) Indian economy earns from industrial activities.

III) Indian economy is dependent on the agricultural sector.

- A. Only I and II
- B. Only II and III
- C. Only I and III
- D. All I, II and III
- E. None of these

Direction: Select the phrase/connector from the given options which can be used to form a single sentence from the two sentences given below, implying the same meaning as expressed in the statement sentences. Pick out the option which when used to start a sentence combines both the above sentences in one.

108. Recently, I was travelling with my wife on the Delhi Metro. Since the train was approaching the last station, there weren't too many passengers.

- I. The train journey was over
- II. It was an empty train
- III. The passengers were getting down
- A. Only I
- B. Only II
- C. Only III
- D. Both I and II
- E. None of these

Direction: In the following question, three statements have been given, and a phrase/idiom has been highlighted in each of them. Identify the statement(s) in which



SBI & IBPS 2022: A Sure Shot Success batch
(Batch 5)
Clear All SBI & IBPS 2022 Exams in First Attempt

START FREE TRIAL

the phrase/idiom fits contextually to convey a logical meaning.

109. Make a long story short

I. To **make a long story short**, the faux pas resulted in the company losing the deal.

II. He was given a well-deserved promotion since he was working on **making a long story short**.

III. He **made a long story short** by restarting the project altogether.

- A. Only I
- B. Only II
- C. Only III
- D. Both I and III
- E. All I, II, and III

110. Hang in there

I. Despite the constant failures, the student decided to **hang in there** until he could see positive results.

II. Returning home exhausted, he decided to **hang in there** as soon as possible.

III. The minister decided to **hang in there** despite losing the popular vote.

- A. Only I
- B. Both I and III
- C. Only II
- D. Both I and II
- E. All I, II, and III

111. In March 2022, what is the trade deficit between India and China's bilateral trade?

- A. US\$ 69.76 billion
- B. US\$ 32.06 billion
- C. US\$ 73.51 billion
- D. US\$ 69.56 billion
- E. US\$ 19.25 billion

112. The second leg of the 11th edition of Rashtriya Sanskriti Mahotsav 2022 was inaugurated in which city?

- A. Rajamahendravaram, Andhra Pradesh
- B. Shivamogga, Karnataka
- C. Kochi, Kerala
- D. Madurai, Tamil Nadu
- E. Warangal, Telangana

113. Which general insurance firm has launched the industry's first digital reward program, VAULT?

- A. HDFC ERGO
- B. ICICI Lombard
- C. TATA AIG
- D. Reliance General Insurance
- E. Acko General Insurance

114. Pradhan Mantri Suraksha Bima Yojana was launched in which year?

- A. 2013
- B. 2014
- C. 2015
- D. 2016
- E. 2017

115. What is 'N' stands for in "YONO App"?

- A. Net
- B. Now
- C. National
- D. Need
- E. Nominal

116. What is the rank of India in HURUN Global U40 Self-Made Billionaires report 2022, which is topped by the USA followed by China?



SBI & IBPS 2022: A Sure Shot Success batch
(Batch 5)
Clear All SBI & IBPS 2022 Exams in First Attempt

START FREE TRIAL

- A. 13th
- B. 04th
- C. 25th
- D. 17th
- E. 07th

117. How much amount has the cabinet approved for the improvement and acceleration of the performance of MSME?

- A. \$318 million
- B. \$100 million
- C. \$507 million
- D. \$945 million
- E. \$808 million

118. Which of the following is not come under eight Core Industries?

- A. Petroleum Refinery
- B. Textiles
- C. Steel
- D. Electricity Generation
- E. Fertilizers

119. EaseMyTrip partners with which bank to launch environment-friendly green international debit card?

- A. ICICI Bank
- B. RBS Bank
- C. DBS Bank
- D. SBI Bank
- E. HDFC Bank

120. Which of the following ministries has launched the UDAN scheme?

- A. Ministry of Civil Aviation
- B. Ministry of Education
- C. Ministry of Home Affairs
- D. Ministry of Defence

E. Ministry of Women and Child Development

121. Recently, RBI has set up the ink manufacturing unit of BRBNMPL named 'Varnika' in which city?

- A. Kochi
- B. Mysuru
- C. Dewas
- D. Nagpur
- E. Mumbai

122. The Ministry of Education (MoE) approved a new scheme "New India Literacy Programme" to be implemented from 2022 to _____.

- A. 2024
- B. 2025
- C. 2026
- D. 2027
- E. 2028

123. Union Budget has increased guarantee cover under ECLGS to _____

- A. Rs 4 Lakhs
- B. Rs 4.5 Lakhs
- C. Rs 5 Lakhs
- D. Rs 5.5 Lakhs
- E. Rs 6 Lakhs

124. At what value the Tata Group has regained control of Air India after 69 years?

- A. Rs 8,000 crore
- B. Rs 10,000 crore
- C. Rs 15,000 crore
- D. Rs 18,000 crore
- E. Rs 20,000 crore



125. What is the theme of the 5th BIMSTEC Summit, which was recently held under the chairmanship of Sri Lanka virtually?

- A. Partnership for Harmony and Prosperity
- B. The need for greater connectivity and regional cooperation between the member nations
- C. Towards a Resilient Region, Prosperous Economies, Healthy People
- D. Towards a Peaceful, Prosperous and Sustainable Bay of Bengal region
- E. No theme for this year

126. In March 2022, Kotak Mahindra has acquired how much stakes in ONDC for 10 crore rupees?

- A. 7.45%
- B. 7.84%
- C. 7.35%
- D. 7.44%
- E. 7.39%

127. Identify the wrong statement based on the state of the economy as per the Economic Survey 2021-22?

- A. Advance estimates suggest that the GVA of Industry (including mining and construction) will rise by 11.8 per cent in 2021-22 after contracting by 7 per cent in 2020-21
- B. The Services sector has been the hardest hit by the pandemic, especially segments that involve human contact.

- C. Due to all the disruptions caused by the global pandemic, India's balance of payments remained in deficit throughout the last two years
- D. India's foreign exchange reserves is equivalent to 13.2 months of merchandise imports and is higher than the country's external debt.
- E. None of the above

128. Who has authored the book titled 'Pride, Prejudice and Punditry'?

- A. Salman Khurshid
- B. P Chidambaram
- C. Shashi Tharoor
- D. Manish Tiwari
- E. Subramanian Swamy

129. With what initial authorized capital the Government of India sets up a National Land Monetisation Corporation?

- A. ₹1000 crores
- B. ₹2000 crores
- C. ₹5000 crores
- D. ₹7000 crores
- E. ₹10,000 crores

130. World Bipolar day observed on which date?

- A. March 28
- B. March 29
- C. March 30
- D. March 31
- E. March 27



SBI & IBPS 2022: A Sure Shot Success batch
(Batch 5)
Clear All SBI & IBPS 2022 Exams in First Attempt

START FREE TRIAL

131. Which company will be the sponsor of the Tata Open Maharashtra tennis tournament for the fourth consecutive year?

- A. Tata Motor
- B. Hyundai Motor
- C. Hero Motocorp
- D. Reliance Industries
- E. ICICI Bank

132. Who has authored the book titled "Gandhi's Assassin: The Making of Nathuram Godse and His Idea of India"?

- A. Jayanta Ghosal
- B. Joyojeet Pal
- C. Barkha Dutt
- D. Shekhar Gupta
- E. Dharendra K. Jha

133. Under whose chairmanship the Securities and Exchange Board of India (SEBI) has reconstituted its alternative investment policy advisory committee, which advises the capital markets regulator on a range of issues that impact further development of the AIF space?

- A. Gopal Srinivasan
- B. Gopal Jain
- C. Vipul Roongta
- D. N R Narayana Murthy
- E. Renuka Ramnath

134. What is the full form of MIBOR?

- A. Multiple Interbank Offer Rate
- B. Marginal Interbank Offer Rate
- C. Mumbai Interbank Offer Rate
- D. Marginal International Offering Rate
- E. None of these

135. Which hockey team has won the Khelo India Women's Hockey League (U-21)?

- A. Pritam Siwach Academy
- B. Kalinga Sports Society
- C. Jawaharlal Nehru Hockey Society
- D. Lal Bahadur Shastri Hockey Academy
- E. Salute Hockey Academy

136. Which of the following schemes has been proposed for MSME under Union Budget 2022-23?

- A. ECLG Scheme
- B. CGTMSE Scheme
- C. PLI Scheme
- D. RAMP programme
- E. PM-DevINE Scheme

137. Reserve Bank of India (RBI) has inaugurated Reserve Bank Innovation Hub in which city?

- A. New Delhi
- B. Mumbai
- C. Bengaluru
- D. Kolkata
- E. Chennai

138. Which multilateral development bank, will spend \$150 million in the creation of data centres that will primarily serve emerging Asia?

- A. New Development Bank
- B. Asian Development Bank
- C. Asian Infrastructure Investment Bank
- D. World Bank
- E. Bank of Japan



SBI & IBPS 2022: A Sure Shot Success batch
(Batch 5)
Clear All SBI & IBPS 2022 Exams in First Attempt

START FREE TRIAL

139. At which institution the Indian Army has announced the establishment of General Bipin Rawat Memorial Chair?

- A. United Service Institution of India (USI)
- B. The Institute for Defence Studies and Analyses (IDSA)
- C. Manohar Parrikar Institute for Defence Studies and Analyses
- D. Observer Research Foundation
- E. None of the above

140. Pradhan Mantri MUDRA Yojana is aimed at:

- A. bringing the small entrepreneurs into formal financial system
- B. providing loans to poor farmers for cultivating particular crops
- C. providing pension to old and destitute persons
- D. funding the voluntary organizations involved in the promotion of skill development and employment generation
- E. None of the above

141. Which state has won the National Para-Swimming Championships 2022?

- A. Tamil Nadu
- B. Maharashtra
- C. Uttarakhand
- D. Karnataka
- E. Goa

142. According to the Atal Ranking of Institutions on Innovation Achievements (ARIIA) 2021, which institute has been recognised as the Most Innovative Educational

Institute in India, in the technical ranking?

- A. Indian Institute of Technology Bombay
- B. Indian Institute of Technology Delhi
- C. Indian Institute of Technology Madras
- D. Indian Institute of Technology Roorkee
- E. Indian Institute of Technology Kanpur

143. Which bank has signed a Memorandum of Understanding (MoU) with Assam Rifles to provide 'Central Forces Salary Package'?

- A. Punjab National Bank
- B. Bank of Baroda
- C. State Bank of India
- D. Canara Bank
- E. Union Bank of India

144. Payment Banks are licensed under which of the following section of the Banking Regulation Act, 1949?

- A. Section 32
- B. Section 22
- C. Section 38
- D. Section 52
- E. Section 36

145. According to Brand Finance's Global 500 study for 2022 which has retained its title as the world's most valuable brand?

- A. Amazon
- B. Google
- C. Microsoft
- D. Apple
- E. Facebook



SBI & IBPS 2022: A Sure Shot Success batch
(Batch 5)
Clear All SBI & IBPS 2022 Exams in First Attempt

START FREE TRIAL

146. Who won the Formula One Saudi Arabia Grand Prix 2022 held at Jeddah Corniche Circuit, Saudi Arabia?

- A. Charles Leclerc
- B. Max Verstappen
- C. Carlos Sainz Jr.
- D. George Russell
- E. Lewis Hamilton

147. The RBI's Digital Payment Index, which shows the deepening of payments through digital modes in India, rose by what per cent in September 2021 against 217.74 in the year-ago month?

- A. 32.75 per cent
- B. 39.64 per cent
- C. 42.67 per cent
- D. 43.50 per cent
- E. 57.50 per cent

148. According to Hurun Global Unicorn Index 2021, what is India's rank in having highest number of unicorns?

- A. 3rd
- B. 4th
- C. 5th
- D. 6th
- E. 7th

149. Which regulatory body has launched Saa ₹thi mobile app to empower investors with the accurate knowledge of security market?

- A. RBI
- B. SEBI
- C. SIDBI
- D. NHB
- E. FSDC

150. Miguel Van Damme passed away, was related to which sports?

- A. Tennis
- B. Badminton
- C. Football
- D. Archery
- E. Swimming

151. Who has taken charge of Forest Research Institute as the new Director?

- A. Arun Singh Rawat
- B. Omkar Singh
- C. Renu Singh
- D. Lalaram Thanga
- E. Preeti Desai

152. Which of the following is the most valued company in terms of Mcap?

- A. Reliance Industries
- B. TCS
- C. HDFC Bank
- D. Infosys
- E. ICICI Bank

153. The country's first Digital Water Bank 'AQVERIUM' was launched in _____.

- A. Ahmedabad
- B. Jaisalmer
- C. Bengaluru
- D. Jaipur
- E. Ranchi

154. Which institution releases the 'Financial Stability Report (FSR)'?

- A. International Monetary Fund (IMF)
- B. NITI Aayog



SBI & IBPS 2022: A Sure Shot Success batch
(Batch 5)
Clear All SBI & IBPS 2022 Exams in First Attempt

START FREE TRIAL

- C. Reserve Bank of India (RBI)
- D. World Bank
- E. Asian Development Bank (ADB)

155. SHWAS and AROG Schemes are two quick delivery schemes for COVID Preparedness. It has been launched by _____.

- A. NABARD
- B. SIDBI
- C. PFRDA
- D. RBI
- E. IDBI

156. Which of the following statements is/are correct regarding the eligibility norms for entities tapping into data from credit information companies (CICs), or credit bureaus, laid down by the Reserve Bank of India?

1. Company must be owned and controlled by resident Indian citizens to become a specified user with a credit bureau.
 2. In order to be eligible as a 'specified user', an entity must be a company incorporated in India or a statutory corporation established in India.
 3. Companies should have a net worth of not less than 2 crore rupees as per the latest audited balance sheet.
- A. Only 2 and 3
 - B. Only 1 and 3
 - C. Only 1 and 2
 - D. Only 3
 - E. All 1, 2 and 3

157. In partnership with the National Payments Corporation of India (NPCI) which bank has

launched a 'RuPay Select Contactless Debit Card' with a host of benefits for its premium/HNI (High Networth Individuals) customers?

- A. UCO Bank
- B. Union Bank of India
- C. Bank of Maharashtra
- D. Indian Bank
- E. Canara Bank

158. Which of the following National Park is not situated in Andaman and Nicobar?

- A. Galathea National Park
- B. Mahatma Gandhi Marine National Park
- C. Mount Harriet National Park
- D. Darrah National Park
- E. None of the above

159. According to the World Economic Outlook report released in January 2022, what will be India's economic growth rate in the fiscal 2021-22 (FY22)?

- A. 8.0 percent
- B. 8.5 percent
- C. 9.0 percent
- D. 9.5 percent
- E. 9.8 percent

160. Digital marketplace for consumer credit, paisabazaar.com has partnered with which bank to launch a pre-qualified program for unsecured loans on its platform?

- A. ICICI Bank
- B. IndusInd Bank
- C. HDFC Bank
- D. Axis Bank
- E. Yes Bank



ANSWERS

1. Ans. A.

The Platinum laptop does not belong to S.

The owner of the Lenovo laptop which is Blue is adjacent to T who does not own a Red laptop. P does not own a Black laptop.

P has an Acer laptop of neither Blue or Red.

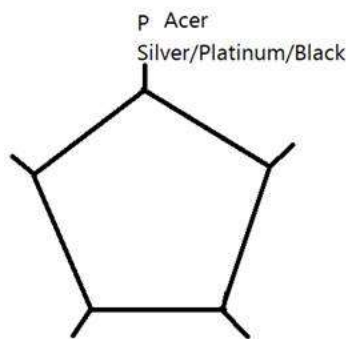

R sits immediate left of T, neither is adjacent to P.

T has a laptop of neither Lenovo nor HP.

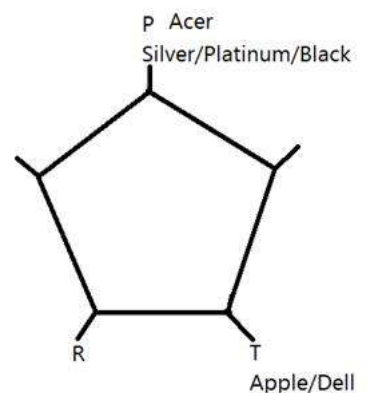

The person having Red laptop sits second to the right of the one having Platinum laptop. R's laptop is not Red.

Case I



Case II

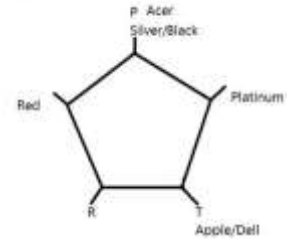

CASE III

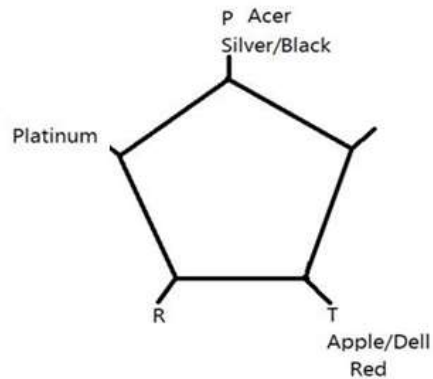

S owns neither Dell nor HP laptop. The owner of Lenovo laptop which is Blue in colour is adjacent to T. Thus, case I is invalid.

Case II

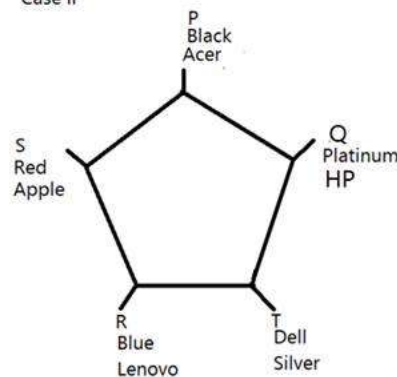

Therefore, this is the final arrangement.



SBI & IBPS 2022: A Sure Shot Success batch (Batch 5)
Clear All SBI & IBPS 2022 Exams in First Attempt

START FREE TRIAL

Thus, no person is seated between the persons having Red and Blue when counted anti-clockwise from the Red laptop owner.

2. Ans. B.

The Platinum laptop does not belong to S.

The owner of the Lenovo laptop which is Blue is adjacent to T who does not own a Red laptop. P does not own a Black laptop.

P have an Acer laptop of neither Blue or Red.

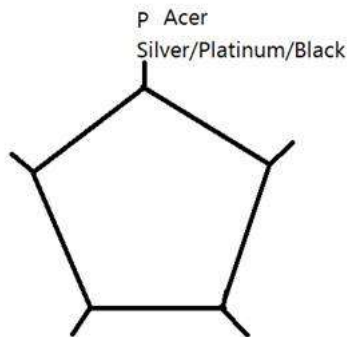

R sits immediate left of T, neither is adjacent to P.

T has a laptop of neither Lenovo nor HP.

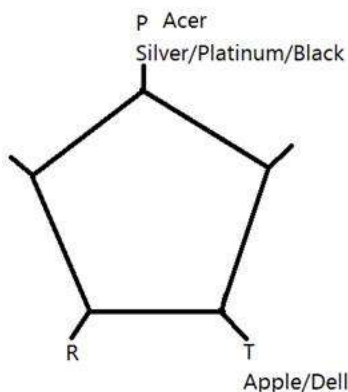

The person having Red laptop sits second to the right of the one having Platinum laptop.

R's laptop is not Red.

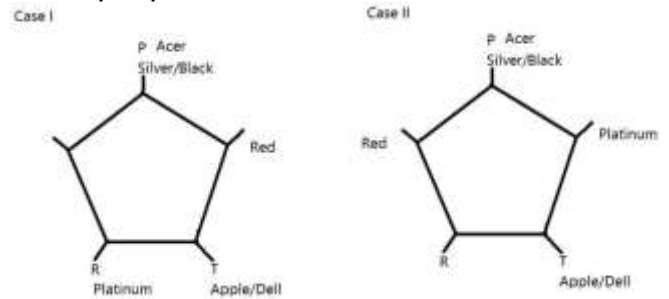

CASE III

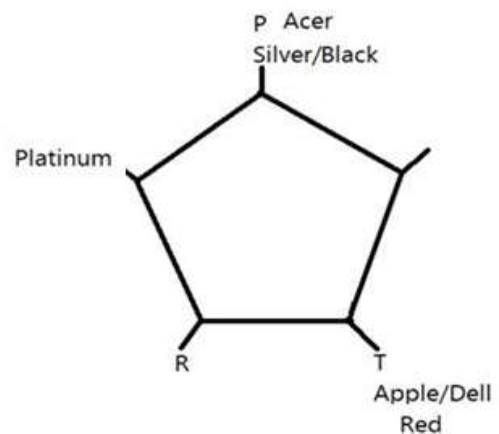

S owns neither Dell nor HP laptop. The owner of Lenovo laptop which is Blue in colour is adjacent to T. Thus, case I is invalid.



SBI & IBPS 2022: A Sure Shot Success batch
(Batch 5)
Clear All SBI & IBPS 2022 Exams in First Attempt

START FREE TRIAL

Case II

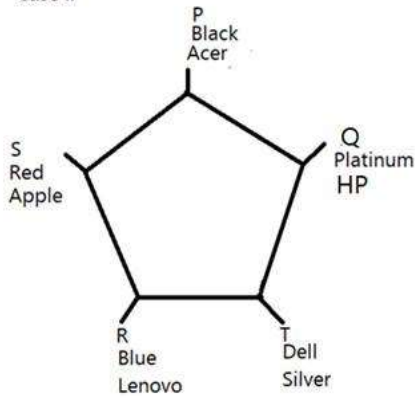

Therefore, this is the final arrangement.

Thus, S owns Red laptop.

3. Ans. D.

The Platinum laptop does not belong to S.

The owner of the Lenovo laptop which is Blue is adjacent to T who does not own a Red laptop. P does not own a Black laptop.

P have an Acer laptop of neither Blue or Red.

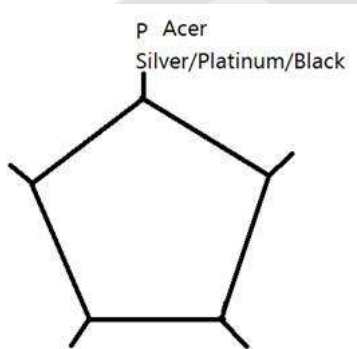

R sits immediate left of T, neither is adjacent to P.

T has a laptop of neither Lenovo nor HP.

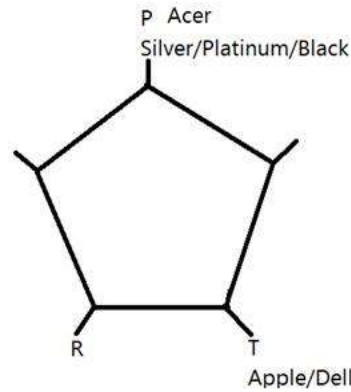

The person having Red laptop sits second to the right of the one having Platinum laptop. R's laptop is not Red.

Case I

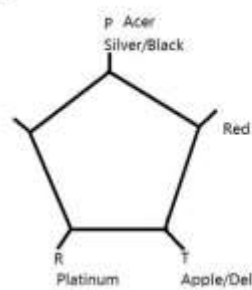

Case II

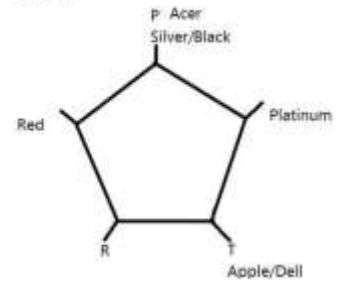

CASE III

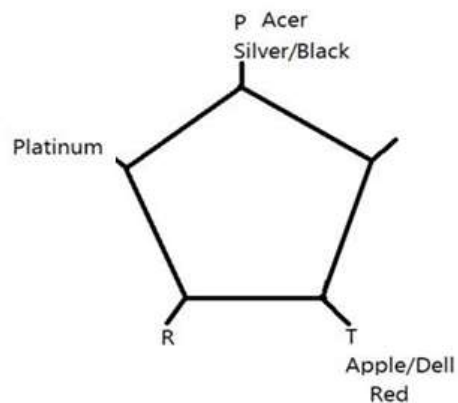

S owns neither Dell nor HP laptop.



SBI & IBPS 2022: A Sure Shot Success batch (Batch 5)
 Clear All SBI & IBPS 2022 Exams in First Attempt

START FREE TRIAL

The owner of Lenovo laptop which is Blue in colour is adjacent to T. Thus, case I is invalid.

Case II

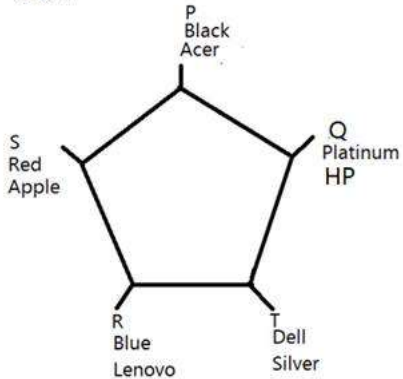

Therefore, this is the final arrangement. Thus, S is immediate neighbour of R.

4. Ans. A.

The Platinum laptop does not belong to S.

The owner of the Lenovo laptop which is Blue is adjacent to T who does not own a Red laptop. P does not own a Black laptop.

P have an Acer laptop of neither Blue or Red.

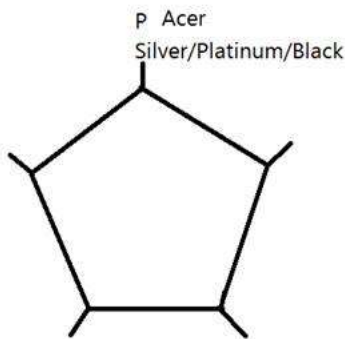

R sits immediate left of T, neither is adjacent to P. T has a laptop of neither Lenovo nor HP.

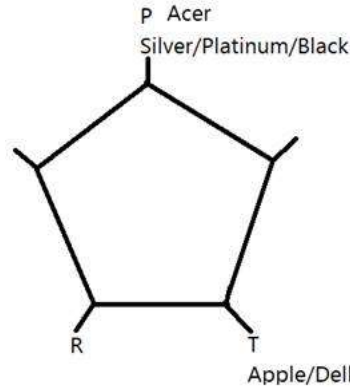

The person having Red laptop sits second to the right of the one having Platinum laptop. R's laptop is not Red.

Case I

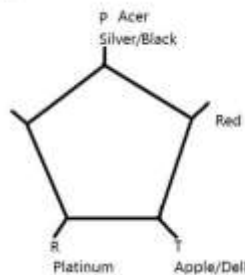

Case II

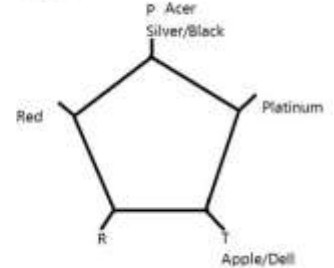

CASE III

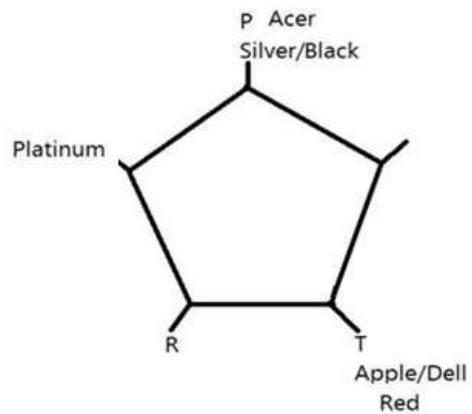

S owns neither Dell nor HP laptop.



SBI & IBPS 2022: A Sure Shot Success batch (Batch 5)
Clear All SBI & IBPS 2022 Exams in First Attempt

START FREE TRIAL

The owner of Lenovo laptop which is Blue in colour is adjacent to T. Thus, case I is invalid.

Case II

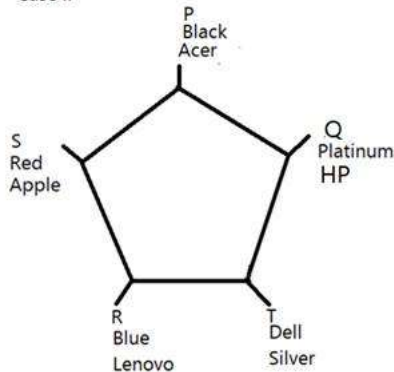

Therefore, this is the final arrangement.

Q has HP laptop.

5. Ans. C.

The Platinum laptop does not belong to S.

The owner of the Lenovo laptop which is Blue is adjacent to T who does not own a Red laptop. P does not own a Black laptop.

P have an Acer laptop of neither Blue or Red.

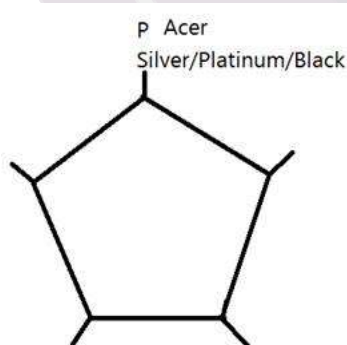

R sits immediate left of T, neither is adjacent to P.

T has a laptop of neither Lenovo nor HP.

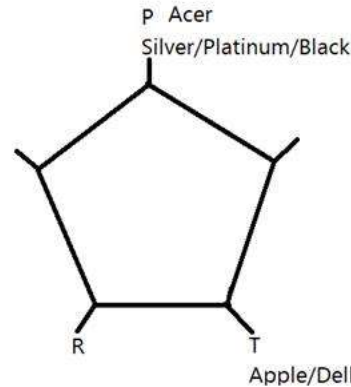

The person having Red laptop sits second to the right of the one having Platinum laptop. R's laptop is not Red.

Case I

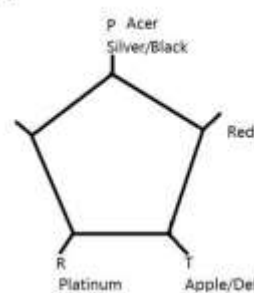

Case II

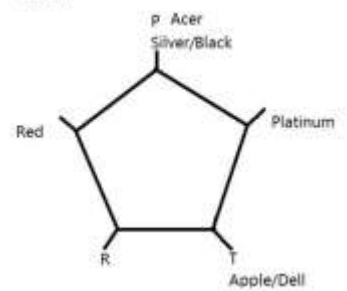

S owns neither Dell nor HP laptop. The owner of Lenovo laptop which is Blue in colour is adjacent to T. Thus, case I is invalid.

Case II

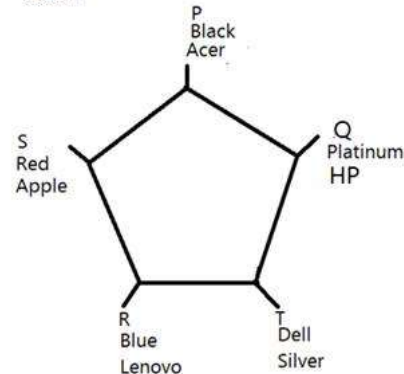

Therefore, this is the final arrangement.



SBI & IBPS 2022: A Sure Shot Success batch (Batch 5)
Clear All SBI & IBPS 2022 Exams in First Attempt

START FREE TRIAL

Hence, R sits third to the left of the Black coloured laptop owner.

6. Ans. D.

Symbol	Relation
+	Male
-	Female
—	Sibling
==	Couple
	Child

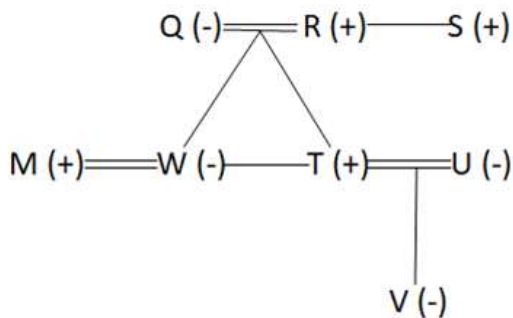

Hence, M is the son-in-law of R.

7. Ans. D.

Symbol	Relation
+	Male
-	Female
—	Sibling
==	Couple
	Child

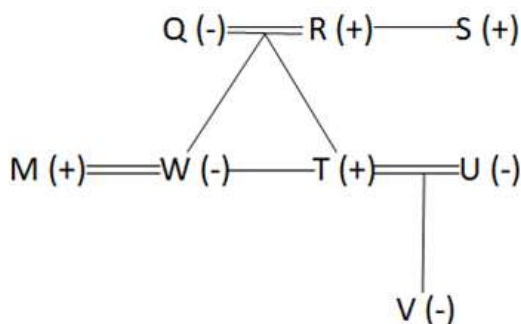

Hence, S is the uncle of T.

8. Ans. E.

Symbol	Relation
+	Male
-	Female
—	Sibling
==	Couple
	Child

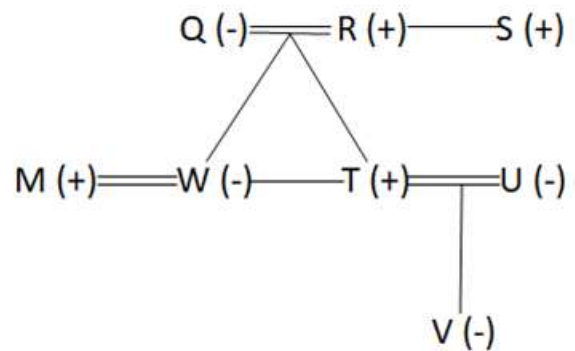

V is a female.

9. Ans. B.

Clearly, 'E' is tenth to the right of eighteenth element from the left end.

10. Ans. B.

A 9 B, O 5 K, U 3 H, E 8 M

Clearly, there are four numbers which are immediately preceded by a vowel and immediately followed by a consonant.

11. Ans. C.

If all the odd numbers are removed from the given series:

T Y V A B N 2 L P O K W 4 Z D F C 6 G U H J E 8 M

Clearly, 'C' is seventeenth element from the left end.

12. Ans. C.

If last ten elements are removed from the given series:



SBI & IBPS 2022: A Sure Shot Success batch
(Batch 5)
Clear All SBI & IBPS 2022 Exams in First Attempt

START FREE TRIAL

T 1 Y V A 9 B N 2 L P O 5 K W 4 Z D
F C

Clearly, 'L' is eleventh letter from the right end.

13. Ans. B.

'7' is the fifth element from the right end and '2' is the ninth element from the left end.

T 1 Y V A 9 B N 2 L P O **5** K W **4** Z
D F C **6** G U **3** H 7 J E 8 M

Clearly, four numbers are there between the fifth element from the right end and ninth element from the left end.

14. Ans. D.

1) H was born on even numbered date in the month having less than 31 days.

2) Number of people were born after H is one more than before A.

Here we have 2 cases:

	Case 1	Case 2
Month and date	People	People
February 2 nd	H	
February 13 th		
March 2 nd		A
March 13 th		
June 2 nd		H
June 13 th		
July 2 nd	A	
July 13 th		

3) Three people were born between A and G.

4) One person was born between A and C.

	Case 1	Case 2
Month and date	People	People
February 2 nd	H	C
February 13 th		
March 2 nd	G	A
March 13 th		
June 2 nd	C	H
June 13 th		
July 2 nd	A	G
July 13 th		

5) Three people were born between F and E.

6) E born in the same month with G.

7) Only one person born between E and B.

8) B and H does not born in the same month.

Case 2 eliminated:

Month and date	People
February 2 nd	H
February 13 th	D
March 2 nd	G
March 13 th	E
June 2 nd	C
June 13 th	B
July 2 nd	A
July 13 th	F

Hence, C was born on 2nd June

15. Ans. C.

1) H was born on even numbered date in the month having less than 31 days.

2) Number of people were born after H is one more than before A.

Here we have 2 cases:



SBI & IBPS 2022: A Sure Shot Success batch
(Batch 5)
Clear All SBI & IBPS 2022 Exams in First Attempt

START FREE TRIAL

	Case 1	Case 2
Month and date	People	People
February 2 nd	H	
February 13 th		
March 2 nd		A
March 13 th		
June 2 nd		H
June 13 th		
July 2 nd	A	
July 13 th		

- 3) Three people were born between A and G.
- 4) One person was born between A and C.

	Case 1	Case 2
Month and date	People	People
February 2 nd	H	C
February 13 th		
March 2 nd	G	A
March 13 th		
June 2 nd	C	H
June 13 th		
July 2 nd	A	G
July 13 th		

- 5) Three people were born between F and E.
- 6) E born in the same month with G.
- 7) Only one person born between E and B.
- 8) B and H does not born in the same month.

Case 2 eliminated:

Month and date	People
February 2 nd	H
February 13 th	D
March 2 nd	G
March 13 th	E
June 2 nd	C
June 13 th	B
July 2 nd	A
July 13 th	F

Hence, H and G were born in the same date
16. Ans. A.

- 1) H was born on even numbered date in the month having less than 31 days.
- 2) Number of people were born after H is one more than before A. Here we have 2 cases:

	Case 1	Case 2
Month and date	People	People
February 2 nd	H	
February 13 th		
March 2 nd		A
March 13 th		
June 2 nd		H
June 13 th		
July 2 nd	A	
July 13 th		

- 3) Three people were born between A and G.
- 4) One person was born between A and C.



SBI & IBPS 2022: A Sure Shot Success batch (Batch 5)
Clear All SBI & IBPS 2022 Exams in First Attempt

START FREE TRIAL

	Case 1	Case 2
Month and date	People	People
February 2 nd	H	C
February 13 th		
March 2 nd	G	A
March 13 th		
June 2 nd	C	H
June 13 th		
July 2 nd	A	G
July 13 th		

- 5) Three people were born between F and E.
- 6) E born in the same month with G.
- 7) Only one person born between E and B.
- 8) B and H does not born in the same month.

Case 2 eliminated:

Month and date	People
February 2 nd	H
February 13 th	D
March 2 nd	G
March 13 th	E
June 2 nd	C
June 13 th	B
July 2 nd	A
July 13 th	F

Hence, two people were born before G

17. Ans. B.

1) H was born on even numbered date in the month having less than 31 days.

2) Number of people were born after H is one more than before A.

Here we have 2 cases:

	Case 1	Case 2
Month and date	People	People
February 2 nd	H	
February 13 th		
March 2 nd		A
March 13 th		
June 2 nd		H
June 13 th		
July 2 nd	A	
July 13 th		

- 3) Three people were born between A and G.
- 4) One person was born between A and C.

	Case 1	Case 2
Month and date	People	People
February 2 nd	H	C
February 13 th		
March 2 nd	G	A
March 13 th		
June 2 nd	C	H
June 13 th		
July 2 nd	A	G
July 13 th		

- 5) Three people were born between F and E.
- 6) E born in the same month with G.
- 7) Only one person born between E and B.
- 8) B and H does not born in the same month.

Case 2 eliminated:



SBI & IBPS 2022: A Sure Shot Success batch (Batch 5)
 Clear All SBI & IBPS 2022 Exams in First Attempt

START FREE TRIAL

Month and date	People
February 2 nd	H
February 13 th	D
March 2 nd	G
March 13 th	E
June 2 nd	C
June 13 th	B
July 2 nd	A
July 13 th	F

Hence, D was born in 13th February.
18. Ans. E.

- 1) H was born on even numbered date in the month having less than 31 days.
- 2) Number of people were born after H is one more than before A. Here we have 2 cases:

	Case 1	Case 2
Month and date	People	People
February 2 nd	H	
February 13 th		
March 2 nd		A
March 13 th		
June 2 nd		H
June 13 th		
July 2 nd	A	
July 13 th		

- 3) Three people were born between A and G.
- 4) One person was born between A and C.

	Case 1	Case 2
Month and date	People	People
February 2 nd	H	C
February 13 th		
March 2 nd	G	A
March 13 th		
June 2 nd	C	H
June 13 th		
July 2 nd	A	G
July 13 th		

- 5) Three people were born between F and E.
 - 6) E born in the same month with G.
 - 7) Only one person born between E and B.
 - 8) B and H does not born in the same month.
- Case 2 eliminated:

Month and date	People
February 2 nd	H
February 13 th	D
March 2 nd	G
March 13 th	E
June 2 nd	C
June 13 th	B
July 2 nd	A
July 13 th	F

Hence, four people were born between D and A.
19. Ans. A.

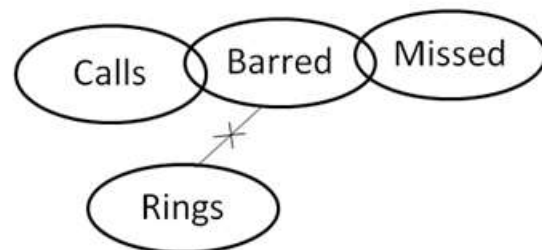

All calls being missed is a possibility
====> follows



SBI & IBPS 2022: A Sure Shot Success batch
(Batch 5)
Clear All SBI & IBPS 2022 Exams in First Attempt

START FREE TRIAL

Some missed are not calls =====> not follows
 Therefore, option A is the correct answer.
 20. Ans. A.

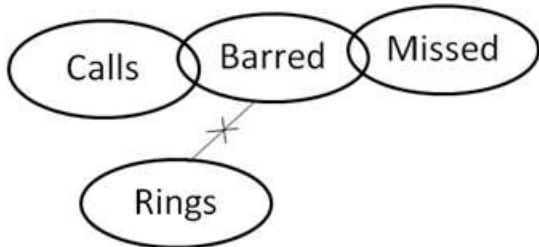

Some calls which are barred being missed is a possibility =====> follows
 All rings are missed =====> not follows
 Therefore, option A is the correct answer.
 21. Ans. A.

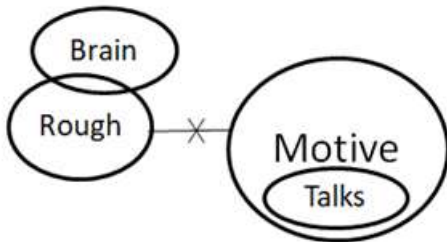

Some brains are not motive =====> follows
 All brains being rough is a possibility =====> not follows
 Therefore, option A is the correct answer.
 22. Ans. C.

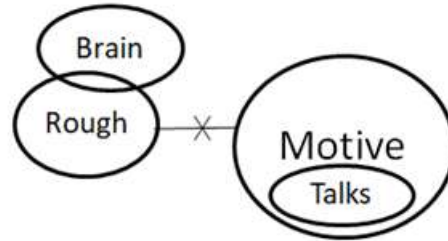

All brains are talks =====> not follows
 Some talks are rough =====> not follows
 All motive being brains is a possibility =====> follows
 Therefore, option C is the correct answer.
 23. Ans. D.
 The 2nd and 3rd letters of AMAZING and 5th and 6th letters of NATURE are M, A, R, and E.
 The words are MARE, RAME
 Hence the first letter is X.
 24. Ans. B.

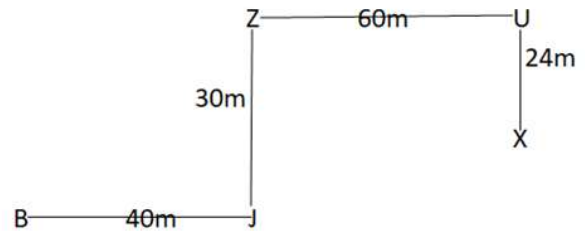

Therefore, option B is the correct answer.
 25. Ans. C.

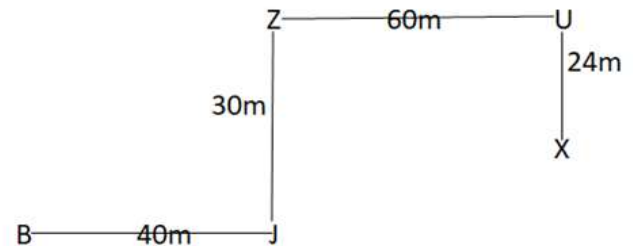

Required distance = $\sqrt{60^2 + 6^2} = 6\sqrt{101}m$

Therefore, option C is the correct answer.

26. Ans. D.

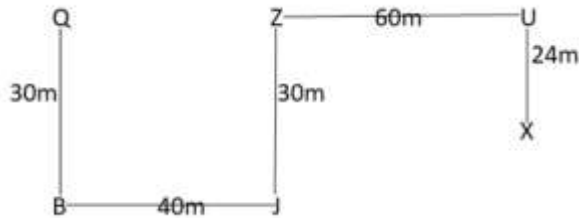

Therefore, option D is the correct answer.

27. Ans. E.

- 1) Circle box is placed at the topmost position.
- 2) Two boxes are placed between Circle box and the triangle box.
- 3) There are at most one box between triangle box and oval box.

Number	Shape of Box			
	Case I	Case II	Case III	Case IV
9	Circle	Circle	Circle	Circle
8	Oval			
7		Oval		
6	Triangle	Triangle	Triangle	Triangle
5			Oval	
4				Oval
3				
2				
1				

4) Trapezium box is immediately below the oval box.

This is not possible in case II, thus case II is eliminated.

Number	Shape of Box		
	Case I	Case III	Case IV
9	Circle	Circle	Circle
8	Oval		
7	Trapezium		
6	Triangle	Triangle	Triangle
5		Oval	
4		Trapezium	Oval
3			Trapezium
2			
1			

5) Square box and rectangle box have six boxes in between them.

6) Rectangle box is below square box.

This is not possible in case I, thus case I get eliminated.

Number	Shape of Box	
	Case III	Case IV
9	Circle	Circle
8	Square	Square
7		
6	Triangle	Triangle
5	Oval	
4	Trapezium	Oval
3		Trapezium
2		
1	Rectangle	Rectangle

7) The pentagon box is immediately below the Hexagon box.

This is not possible in case IV, thus case IV is eliminated and we get,



SBI & IBPS 2022: A Sure Shot Success batch (Batch 5)
 Clear All SBI & IBPS 2022 Exams in First Attempt

START FREE TRIAL

Number	Shape of Box
9	Circle
8	Square
7	Octagon
6	Triangle
5	Oval
4	Trapezium
3	Hexagon
2	Pentagon
1	Rectangle

Clearly, none of the statements is true.

28. Ans. E.

- 1) Circle box is placed at the topmost position.
- 2) Two boxes are placed between Circle box and the triangle box.
- 3) There are at most one box between triangle box and oval box.

Number	Shape of Box			
	Case I	Case II	Case III	Case IV
9	Circle	Circle	Circle	Circle
8	Oval			
7		Oval		
6	Triangle	Triangle	Triangle	Triangle
5			Oval	
4				Oval
3				
2				
1				

- 4) Trapezium box is immediately below the oval box.
This is not possible in case II, thus case II is eliminated.

Number	Shape of Box		
	Case I	Case III	Case IV
9	Circle	Circle	Circle
8	Oval		
7	Trapezium		
6	Triangle	Triangle	Triangle
5		Oval	
4		Trapezium	Oval
3			Trapezium
2			
1			

- 5) Square box and rectangle box have six boxes in between them.
- 6) Rectangle box is below square box.
This is not possible in case I, thus case I get eliminated.

Number	Shape of Box	
	Case III	Case IV
9	Circle	Circle
8	Square	Square
7		
6	Triangle	Triangle
5	Oval	
4	Trapezium	Oval
3		Trapezium
2		
1	Rectangle	Rectangle

- 7) The pentagon box is immediately below the Hexagon box.
This is not possible in case IV, thus case IV is eliminated and we get,



SBI & IBPS 2022: A Sure Shot Success batch (Batch 5)
Clear All SBI & IBPS 2022 Exams in First Attempt

START FREE TRIAL

Number	Shape of Box
9	Circle
8	Square
7	Octagon
6	Triangle
5	Oval
4	Trapezium
3	Hexagon
2	Pentagon
1	Rectangle

Clearly, none of the pairs is correctly matched.

29. Ans. D.

- 1) Circle box is placed at the topmost position.
- 2) Two boxes are placed between Circle box and the triangle box.
- 3) There are at most one box between triangle box and oval box.

Number	Shape of Box			
	Case I	Case II	Case III	Case IV
9	Circle	Circle	Circle	Circle
8	Oval			
7		Oval		
6	Triangle	Triangle	Triangle	Triangle
5			Oval	
4				Oval
3				
2				
1				

- 4) Trapezium box is immediately below the oval box.
This is not possible in case II, thus case II is eliminated.

Number	Shape of Box		
	Case I	Case III	Case IV
9	Circle	Circle	Circle
8	Oval		
7	Trapezium		
6	Triangle	Triangle	Triangle
5		Oval	
4		Trapezium	Oval
3			Trapezium
2			
1			

- 5) Square box and rectangle box have six boxes in between them.
- 6) Rectangle box is below square box.
This is not possible in case I, thus case I get eliminated.

Number	Shape of Box	
	Case III	Case IV
9	Circle	Circle
8	Square	Square
7		
6	Triangle	Triangle
5	Oval	
4	Trapezium	Oval
3		Trapezium
2		
1	Rectangle	Rectangle

- 7) The pentagon box is immediately below the Hexagon box.
This is not possible in case IV, thus case IV is eliminated and we get,



SBI & IBPS 2022: A Sure Shot Success batch (Batch 5)
Clear All SBI & IBPS 2022 Exams in First Attempt

START FREE TRIAL

Number	Shape of Box
9	Circle
8	Square
7	Octagon
6	Triangle
5	Oval
4	Trapezium
3	Hexagon
2	Pentagon
1	Rectangle

Clearly, number 7 is written on the octagon box.

30. Ans. B.

- 1) Circle box is placed at the topmost position.
- 2) Two boxes are placed between Circle box and the triangle box.
- 3) There are at most one box between triangle box and oval box.

Number	Shape of Box			
	Case I	Case II	Case III	Case IV
9	Circle	Circle	Circle	Circle
8	Oval			
7		Oval		
6	Triangle	Triangle	Triangle	Triangle
5			Oval	
4				Oval
3				
2				
1				

- 4) Trapezium box is immediately below the oval box. This is not possible in case II, thus case II is eliminated.

Number	Shape of Box		
	Case I	Case III	Case IV
9	Circle	Circle	Circle
8	Oval		
7	Trapezium		
6	Triangle	Triangle	Triangle
5		Oval	
4		Trapezium	Oval
3			Trapezium
2			
1			

- 5) Square box and rectangle box have six boxes in between them.
- 6) Rectangle box is below square box. This is not possible in case I, thus case I get eliminated.

Number	Shape of Box	
	Case III	Case IV
9	Circle	Circle
8	Square	Square
7		
6	Triangle	Triangle
5	Oval	
4	Trapezium	Oval
3		Trapezium
2		
1	Rectangle	Rectangle

- 7) The pentagon box is immediately below the Hexagon box. This is not possible in case IV, thus case IV is eliminated and we get,



SBI & IBPS 2022: A Sure Shot Success batch (Batch 5)
 Clear All SBI & IBPS 2022 Exams in First Attempt

START FREE TRIAL

Number	Shape of Box
9	Circle
8	Square
7	Octagon
6	Triangle
5	Oval
4	Trapezium
3	Hexagon
2	Pentagon
1	Rectangle

Clearly, the box on which number 2 is written is of pentagon shape.

31. Ans. A.

- 1) Circle box is placed at the topmost position.
- 2) Two boxes are placed between Circle box and the triangle box.
- 3) There are at most one box between triangle box and oval box.

Number	Shape of Box			
	Case I	Case II	Case III	Case IV
9	Circle	Circle	Circle	Circle
8	Oval			
7		Oval		
6	Triangle	Triangle	Triangle	Triangle
5			Oval	
4				Oval
3				
2				
1				

- 4) Trapezium box is immediately below the oval box. This is not possible in case II, thus case II is eliminated.

Number	Shape of Box		
	Case I	Case III	Case IV
9	Circle	Circle	Circle
8	Oval		
7	Trapezium		
6	Triangle	Triangle	Triangle
5		Oval	
4		Trapezium	Oval
3			Trapezium
2			
1			

- 5) Square box and rectangle box have six boxes in between them.
- 6) Rectangle box is below square box. This is not possible in case I, thus case I get eliminated.

Number	Shape of Box	
	Case III	Case IV
9	Circle	Circle
8	Square	Square
7		
6	Triangle	Triangle
5	Oval	
4	Trapezium	Oval
3		Trapezium
2		
1	Rectangle	Rectangle

- 7) The pentagon box is immediately below the Hexagon box. This is not possible in case IV, thus case IV is eliminated and we get,



SBI & IBPS 2022: A Sure Shot Success batch (Batch 5)
 Clear All SBI & IBPS 2022 Exams in First Attempt

START FREE TRIAL

Number	Shape of Box
9	Circle
8	Square
7	Octagon
6	Triangle
5	Oval
4	Trapezium
3	Hexagon
2	Pentagon
1	Rectangle

Clearly, the box on which number 4 is written is of trapezium shape.

32. Ans. C.

Number of boys is = $90 * (2/3) = 60$

Number of girls = $90 - 60 = 30$

Prakash is ranked with 13 i.e. 12 students are ahead of him in who five are girls. So, number of boys who is ahead is 7.

Number of boys after him in the class is = $60 - 7 - 1 = 52$ boys.

Hence option C is correct.

33. Ans. D.

There is no standard set in the statement that could tell us about the 'hit' or 'flop' status of GST. Hence, option D is the correct option.

34. Ans. E.

The correct answer is **option E**, i.e. **Only I is implicit**.

An assumption is a thing that is accepted as true or as certain to happen, without proof.

From the statement, it is evident that Jet Airways has trimmed its fleet by 28 planes and will ground about a dozen more aircraft in March mainly due to non-payment

of rentals. And other supporting information is also evident.

Assumption (I) can be assumed on the basis of the fact that since the airline is trimming down its fleet thus, it has to make adjustments for the customers and has to keep them informed regarding change of plans related to accommodation or flight schedules. It is a suitable assumption in the same direction as the flow of ideas and is not specific to a particular scenario.

Assumption (II) is specific in the sense of getting approval from the stake holders. It covers a specific aspect of the impact and is thus not backed up by the information stated. Thus, it is rejected.

Thus, only assumption (I) is relevant and hence and the most appropriate answer choice is option E

35. Ans. E.

The main statement talks about the measures to be taken to prevent the occurrence of bad debts. The given courses of action are some of the important steps to be taken in this process. To ensure that debts taken are repaid promptly, the customers' requirements and future prospects ought to be studied and their work constantly checked. Thus, both the courses follow.

36. Ans. B.

1. Q sits fourth to the right of G, who sits third from an end.

2. Five people sit between Q and R, who sits second to the left of P.

3. M sits fourth to the right of P.



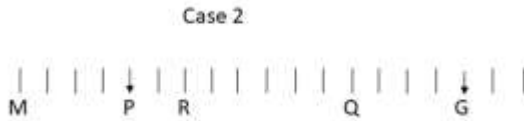
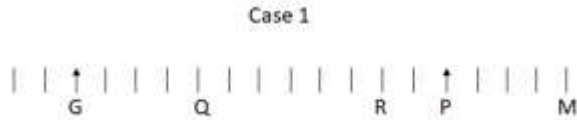

4. Seven people sit between N and M.
5. N and P face the opposite direction.
6. At most eleven people sit to the right of N.
7. Five people sit between N and S, who sits fourth from an end.

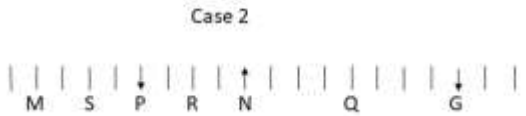
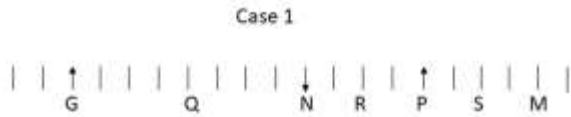

8. S faces the north direction.
9. J sits fifth to the right of S.
(Here, case 1 will be eliminated and we will continue with the case 2)

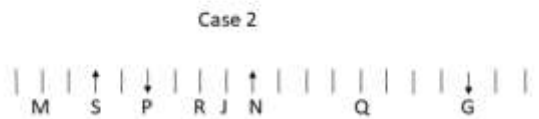
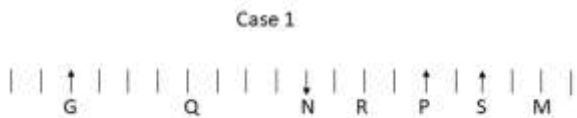

10. R and J (both face the opposite directions) are not sitting to the right of M.

11. M and Q (who is not sitting to the right of J) face the opposite directions.

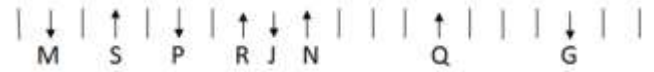

Hence, the required answer is 'Six'.
37. Ans. D.

1. Q sits fourth to the right of G, who sits third from an end.
2. Five people sit between Q and R, who sits second to the left of P.
3. M sits fourth to the right of P.

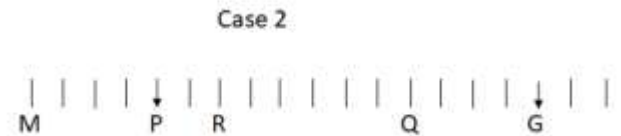
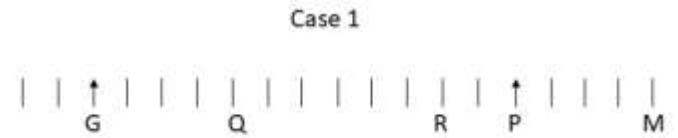

4. Seven people sit between N and M.
5. N and P face the opposite direction.
6. At most eleven people sit to the right of N.
7. Five people sit between N and S, who sits fourth from an end.

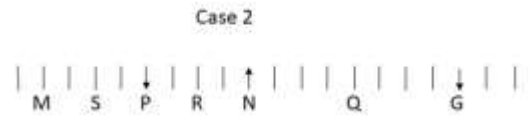
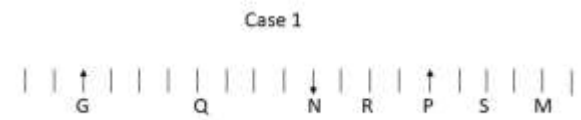

8. S faces the north direction.
9. J sits fifth to the right of S.



SBI & IBPS 2022: A Sure Shot Success batch
(Batch 5)
Clear All SBI & IBPS 2022 Exams in First Attempt

START FREE TRIAL

(Here, case 1 will be eliminated and we will continue with the case 2)

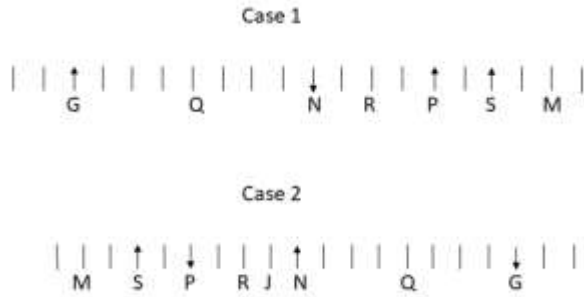

10. R and J (both face the opposite directions) are not sitting to the right of M.

11. M and Q (who is not sitting to the right of J) face the opposite directions.

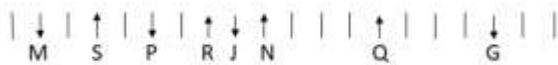

Hence, the required answer is 'Third to the left'.

38. Ans. D.

1. Q sits fourth to the right of G, who sits third from an end.
2. Five people sit between Q and R, who sits second to the left of P.
3. M sits fourth to the right of P.

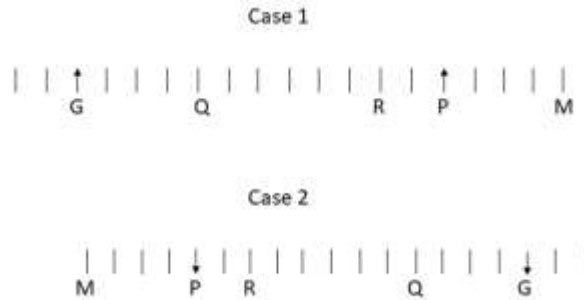

4. Seven people sit between N and M.
5. N and P face the opposite direction.

6. At most eleven people sit to the right of N.

7. Five people sit between N and S, who sits fourth from an end.

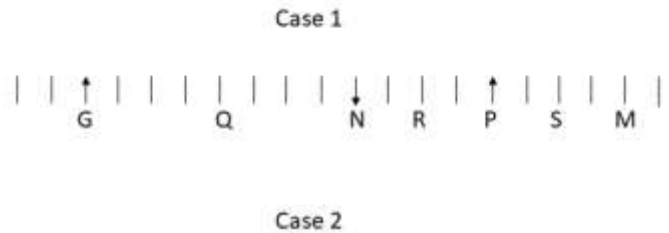

8. S faces the north direction.

9. J sits fifth to the right of S.

(Here, case 1 will be eliminated and we will continue with the case 2)

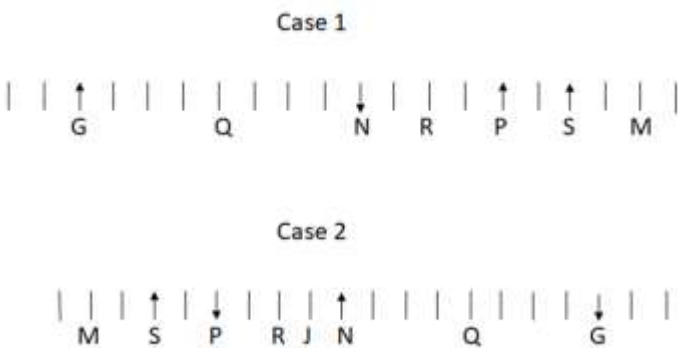

10. R and J (both face the opposite directions) are not sitting to the right of M.

11. M and Q (who is not sitting to the right of J) face the opposite directions.



Hence, the required answer is '20'.

39. Ans. C.

1. Q sits fourth to the right of G, who sits third from an end.



SBI & IBPS 2022: A Sure Shot Success batch
(Batch 5)
Clear All SBI & IBPS 2022 Exams in First Attempt

START FREE TRIAL

2. Five people sit between Q and R, who sits second to the left of P.
3. M sits fourth to the right of P.

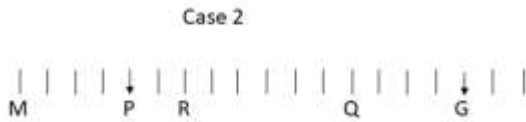
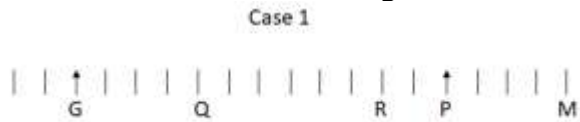

4. Seven people sit between N and M.
5. N and P face the opposite direction.
6. At most eleven people sit to the right of N.
7. Five people sit between N and S, who sits fourth from an end.

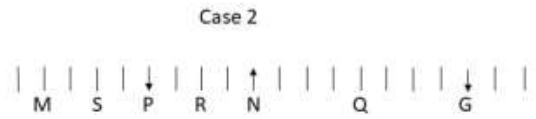
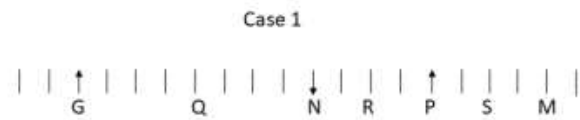

8. S faces the north direction.
9. J sits fifth to the right of S. (Here, case 1 will be eliminated and we will continue with the case 2)

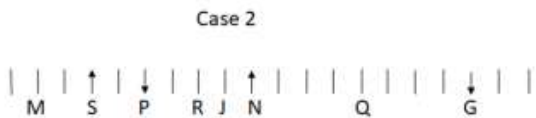
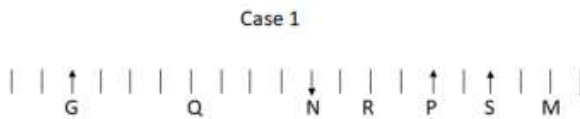

10. R and J (both face the opposite directions) are not sitting to the right of M.
11. M and Q (who is not sitting to the right of J) face the opposite directions.

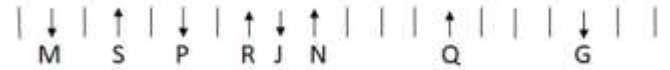

Hence, the required answer is 'N'.
40. Ans. E.

1. Q sits fourth to the right of G, who sits third from an end.
2. Five people sit between Q and R, who sits second to the left of P.
3. M sits fourth to the right of P.

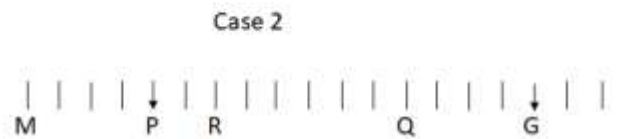

4. Seven people sit between N and M.
5. N and P face the opposite direction.
6. At most eleven people sit to the right of N.
7. Five people sit between N and S, who sits fourth from an end.

SBI & IBPS 2022: A Sure Shot Success batch (Batch 5)
Clear All SBI & IBPS 2022 Exams in First Attempt

START FREE TRIAL

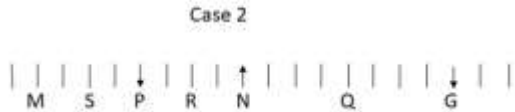

8. S faces the north direction.
 9. J sits fifth to the right of S.
 (Here, case 1 will be eliminated and we will continue with the case 2)

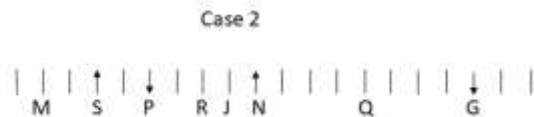
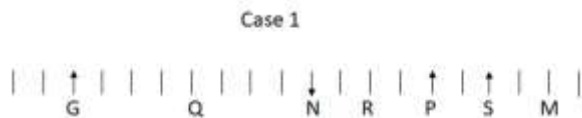

10. R and J (both face the opposite directions) are not sitting to the right of M.
 11. M and Q (who is not sitting to the right of J) face the opposite directions.

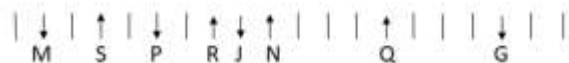

S and R face the same direction.
 41. Ans. A.
 Income of Company C in 2019 = 56 Lakh
 Profit % of Company C in 2019 = 40%
 Now applying the formula of Profit % :

$$\text{Profit \%} = \frac{\text{Income} - \text{Expenditure}}{\text{Expenditure}} \times 100$$

$$40 = \frac{56,00,000 - \text{Expenditure}}{\text{Expenditure}} \times 100$$

$$0.4 \times \text{Expenditure} = 56,00,000 - \text{Expenditure}$$

$$1.4 \times \text{Expenditure} = 56,00,000$$

$$\text{Expenditure} = \frac{56,00,000}{1.4}$$

Expenditure = 40 Lakh

42. Ans. D.
 Expenditure of Company A in 2018 = 35 Lakh

Profit % of Company A in 2018 = 45%

Now applying the formula of Profit % :

$$\text{Profit \%} = \frac{\text{Income} - \text{Expenditure}}{\text{Expenditure}} \times 100$$

$$45 = \frac{\text{Income} - 35,00,000}{35,00,000} \times 100$$

$$45 = \frac{\text{Income} - 35,00,000}{35,00,000} \times 100$$

$$45 = \frac{\text{Income} - 35,00,000}{35,00,000} \times 100$$

$$15,75,000 = \text{Income} - 35,00,000$$

$$\text{Income} = 15,75,000 + 35,00,000$$

Income = 50.75 Lakh

43. Ans. E.
 Sum of Income of Company A , B , C in the year 2018 = 72 Lakh

We can not find the sum of Expenditure of these Companies since they all have different Profit % in the year 2018 and also the ratio their individual income is not given.

So, we Can't be determined the sum of their Expenditure.

44. Ans. D.
 Income of Company A in 2019 = 55 Lakh

Profit % of Company A in 2019 = 35%

Now applying the formula of Profit % :



SBI & IBPS 2022: A Sure Shot Success batch
 (Batch 5)
 Clear All SBI & IBPS 2022 Exams in First Attempt

START FREE TRIAL

$$\text{Profit \%} = \frac{\text{Income} - \text{Expenditure}}{\text{Expenditure}} \times 100$$

$$35 = \frac{55,00,000 - \text{Expenditure}}{\text{Expenditure}} \times 100$$

$$0.35 \times \text{Expenditure} = 55,00,000 - \text{Expenditure}$$

$$1.35 \times \text{Expenditure} = 55,00,000$$

$$\text{Expenditure} = \frac{55,00,000}{1.35}$$

$$\text{Profit} = \text{Income} - \text{Expenditure}$$

$$\text{Profit} = 55,00,000 - \frac{55,00,000}{1.35}$$

$$\text{Profit} = \frac{0.35 \times 55,00,000}{1.35}$$

Profit = 14.26 Lakh

45. Ans. B.

Let the Expenditure of Company D in 2018 & 2019 equals to E .

Profit % of Company D in 2018 = 50%

Profit % of Company D in 2019 = 55%

Let the Income of Company D in 2018 = I_1

Let the Income of Company D in 2019 = I_2

$$\text{For the year 2018 : } \frac{50}{100} = \frac{I_1 - E}{E}$$

$$I_1 = 1.5 \times E \dots\dots\dots \text{eqn. 1}$$

$$\text{For the year 2019 : } \frac{55}{100} = \frac{I_2 - E}{E}$$

$$I_2 = 1.55 \times E \dots\dots\dots \text{eqn. 2}$$

Divide eqn. 1 by eqn. 2

$$\frac{I_1}{I_2} = \frac{1.5 \times E}{1.55 \times E}$$

$$I_1 : I_2 = 30 : 31$$

46. Ans. D.

Pattern of series is:

$$100 \times 1 + 2 = 102$$

$$102 \times 3 + 4 = 310$$

$$310 \times 5 + 6 = 1556$$

$$1556 \times 7 + 8 = 10900$$

$$10900 \times 9 + 10 = 98110$$

Hence, 10900 will come in place of question mark.

47. Ans. A.

The pattern of the series is:

$$14 + 56 = 70$$

$$70 + 28 = 98$$

$$98 + 14 = 112$$

$$112 + 7 = 119$$

$$119 + 3.5 = 122.5$$

Hence, the missing number is 122.5.

48. Ans. E.

Pattern of the series is:

$$2 \times 4 + 10 = 18$$

$$18 \times 4 + 10 = 82$$

$$82 \times 4 + 10 = 338$$

$$338 \times 4 + 10 = 1362$$

$$1362 \times 4 + 10 = 5458$$

Hence, 5458 will come in place of question mark.

49. Ans. B.

Pattern of the series is:

$$3^2 - 3 = 6$$

$$5^2 - 3 = 22$$

$$7^2 - 3 = 46$$

$$9^2 - 3 = 78$$

$$11^2 - 3 = 118$$

$$13^2 - 3 = 166$$

50. Ans. A.

Pattern of the series is:

$$9.5 \times 5 = 47.5$$

$$47.5 \times 4.5 = 213.75$$

$$213.75 \times 4 = 855$$

$$855 \times 3.5 = 2992.50$$

$$2992.50 \times 3 = 8977.50$$



SBI & IBPS 2022: A Sure Shot Success batch
(Batch 5)
Clear All SBI & IBPS 2022 Exams in First Attempt

START FREE TRIAL

$$8977.50 \times 2.5 = 22443.75$$

51. Ans. A.

I. $2x^2 - 5x + 2 = 0$

$$\Rightarrow 2x^2 - 4x - x + 2 = 0$$

$$\Rightarrow 2x(x - 2) - 1(x - 2) = 0$$

$$\Rightarrow (2x - 1)(x - 2) = 0$$

$$\Rightarrow x = \frac{1}{2}, 2$$

II. $3y^2 + 28y + 9 = 0$

$$\Rightarrow 3y^2 + 27y + y + 9 = 0$$

$$\Rightarrow 3y(y + 9) + 1(y + 9) = 0$$

$$\Rightarrow (3y + 1)(y + 9) = 0$$

$$\Rightarrow y = -\frac{1}{3}, -9$$

Hence, $y < x$.

52. Ans. E.

I. $x^2 - 8x + \sqrt{144} = 0$

$$\Rightarrow x^2 - 6x - 2x + 12 = 0$$

$$\Rightarrow x(x - 6) - 2(x - 6) = 0$$

$$\Rightarrow (x - 6)(x - 2) = 0$$

$$\Rightarrow x = 6, 2$$

II. $2y^2 - 21y = 3y$

$$\Rightarrow 2y^2 = 3y + 21y$$

$$\Rightarrow y^2 = 12y$$

$$\Rightarrow y^2 - 12y = 0$$

$$\Rightarrow y(y - 12) = 0$$

$$\Rightarrow y = 0, 12$$

x	Relation	y
6	<	12
6	>	0
2	>	0
2	<	12

Hence, relationship between x and y can't be established.

53. Ans. E.

I. $14X^2 + 6X = 3X + 2$

$$\Rightarrow 14X^2 + 3X - 2 = 0$$

$$\Rightarrow 14X^2 + 7X - 4X - 2 = 0$$

$$\Rightarrow 7X(2X + 1) - 2(2X + 1) = 0$$

$$\Rightarrow (2X + 1)(7X - 2) = 0$$

$$\Rightarrow X = -\frac{1}{2} \text{ and } \frac{2}{7}$$

II. $5Y^2 + 8Y = 6Y + 3$

$$\Rightarrow 5Y^2 + 2Y - 3 = 0$$

$$\Rightarrow 5Y^2 + 5Y - 3Y - 3 = 0$$

$$\Rightarrow 5Y(Y + 1) - 3(Y + 1) = 0$$

$$\Rightarrow (Y + 1)(5Y - 3) = 0$$

$$\Rightarrow Y = -1 \text{ and } \frac{3}{5}$$

Hence, no relation can be established.

54. Ans. B.

I. $8X^2 + \frac{1}{4} = \frac{12X}{4}$

$$\Rightarrow 32X^2 - 12X + 1 = 0$$

$$\Rightarrow 32X^2 - 8X - 4X + 1 = 0$$

$$\Rightarrow 8X(4X - 1) - 1(4X - 1) = 0$$

$$\Rightarrow (4X - 1)(8X - 1) = 0$$

$$\Rightarrow X = \frac{1}{4} \text{ and } \frac{1}{8}$$

II. $9Y^2 - 6Y + 1 = 0$

$$\Rightarrow 9Y^2 - 3Y - 3Y + 1 = 0$$

$$\Rightarrow 3Y(3Y - 1) - 1(3Y - 1) = 0$$

$$\Rightarrow (3Y - 1)(3Y - 1) = 0$$

$$\Rightarrow Y = \frac{1}{3}$$

Hence, $X < Y$.

55. Ans. B.

I. $x^2 - 27x + 162 = 0$

$$\Rightarrow x^2 - 9x - 18x + 162 = 0$$

$$\Rightarrow x(x - 9) - 18(x - 9) = 0$$

$$\Rightarrow (x - 9)(x - 18) = 0$$

$$\Rightarrow x = 9, 18$$

II. $y^2 - 43y + 450 = 0$

$$\Rightarrow y^2 - 18y - 25y + 450 = 0$$



SBI & IBPS 2022: A Sure Shot Success batch
(Batch 5)

Clear All SBI & IBPS 2022 Exams in First Attempt

START FREE TRIAL

$$\begin{aligned} \Rightarrow y(y - 18) - 25(y - 18) &= 0 \\ \Rightarrow (y - 25)(y - 18) &= 0 \\ \Rightarrow y &= 18, 25 \end{aligned}$$

x	Relation	y
9	<	18
9	<	25
18	=	18
18	<	25

So, $x \leq y$.

Hence, option B is correct.

56. Ans. A.

Let the female population of the village in 2018 be '400x'.

So, the male population of the village in 2018 = $400x \times 1.5 = 600x$

Male population of the village in 2020 = $1.25 \times 1.25 \times 600x = 937.5x$

Female population of the village in 2020 = $0.80 \times 0.80 \times 400x = 256x$

So, the population of the village in 2020 = $937.5x + 256x = 1193.5x$

Percentage increase in population = $\frac{1193.5x - 1000x}{1000x} \times 100 = 19.35\%$

57. Ans. A.

$$\begin{aligned} \text{Capital invested by Chirag} &= 1 - \left(\frac{2}{3} + \frac{1}{4} \right) \\ &= \frac{1}{12} \end{aligned}$$

$$\begin{aligned} \text{Ratio of profit} &= \frac{2}{9} : \frac{1}{6} : \frac{1}{12} \\ &= 8 : 6 : 3 \end{aligned}$$

$$\begin{aligned} \text{Sneha's share} &= \frac{6}{8+6+3} \times 3060 \\ &= 6 \times 180 \\ &= \text{Rs. } 1080 \end{aligned}$$

58. Ans. C.

Let speed of boat in still water be V_b km/h.

Let speed of stream be V_r km/h and distance travelled upstream be d km.

$$V_b + V_r = \frac{3}{2}(V_b - V_r)$$

$$\Rightarrow 2V_b + 2V_r = 3V_b - 3V_r$$

$$\Rightarrow V_b = 5V_r$$

Let the distance travelled by boat be d km.

$$\frac{d}{V_b - V_r} = 4$$

$$\Rightarrow \frac{d}{5V_r - V_r} = 4 \Rightarrow \frac{d}{V_r} = 16$$

\therefore Time taken = 16 h

59. Ans. A.

Let the cost prices of each mobile and earphone be Rs. 'x'.

Marked price of the mobile = Rs. $1.6x$

Selling price of the mobile = $1.6x \times 0.75 = \text{Rs. } 1.2x$

Marked price of the earphone = Rs. $1.5x$

Selling price of the earphone = $1.5x \times 0.70 = \text{Rs. } 1.05x$

According to question,



SBI & IBPS 2022: A Sure Shot Success batch
(Batch 5)
Clear All SBI & IBPS 2022 Exams in First Attempt

START FREE TRIAL

$$1.2x + 1.05x - 2x = 2500$$

$$\Rightarrow 0.25x = 2500$$

$$\Rightarrow x = 10000$$

So, the cost price of the mobile = Rs. 10,000

60. Ans. A.

By the rule of M.D.H rule

$$10m \times 12 = 25w \times 12$$

$$\Rightarrow 120m = 300w$$

$$\Rightarrow m/w = 300/120$$

$$\Rightarrow m/w = 5/2$$

Let total units of work = $10 \times 5 \times$

$$12 = 600 \text{ units}$$

Units of work done in one day =

$$600/20 = 30 \text{ units}$$

So,

$$x \times 5 + 2(x + 8) = 30$$

$$\Rightarrow 5x + 2x + 16 = 30$$

$$\Rightarrow 7x = 14$$

$$\Rightarrow x = 2$$

Number of women = $2 + 8 = 10$ women

61. Ans. B.

By approximation, we get:

$$15 \times (?)^3 + (15)^2 = (40)^2 - 400$$

$$\Rightarrow 15 \times (?)^3 + 225 = 1600 - 400$$

$$\Rightarrow 15 \times (?)^3 + 225 = 1200$$

$$\Rightarrow 15 \times (?)^3 = 1200 - 225$$

$$\Rightarrow 15 \times (?)^3 = 975$$

$$\Rightarrow (?)^3 = 975 \div 15$$

$$\Rightarrow (?)^3 = 65 \approx 64$$

$$\Rightarrow ? = \sqrt[3]{64} = 4$$

62. Ans. A.

By approximation, we get:

$$\frac{1040}{?} - 1340 = 20\% \text{ of } 900 - 1440$$

$$\Rightarrow \frac{1040}{?} - 1340 = \frac{20}{100} \times 900 - 1440$$

$$\Rightarrow \frac{1040}{?} = 1340 + 180 - 1440$$

$$\Rightarrow \frac{1040}{?} = 80$$

$$\Rightarrow ? = \frac{1040}{80} = 13$$

63. Ans. C.

By approximation, we get:

$$\frac{50 \times \sqrt{?}}{60} = 16^2 - 9^2$$

$$\Rightarrow \frac{5 \times \sqrt{?}}{6} = (16 + 9)(16 - 9)$$

$$\Rightarrow \sqrt{?} = \frac{25 \times 7 \times 6}{5}$$

$$\Rightarrow \sqrt{?} = 210$$

$$\Rightarrow ? = 44100$$

64. Ans. A.

$$(9.12 \times 6.01 - 4.99 \times 7.89) \times ? = 6.99$$

$$\Rightarrow (9 \times 6 - 5 \times 8) \times ? = 7$$

$$\Rightarrow (54 - 40) \times ? = 7$$

$$\Rightarrow 14 \times ? = 7$$

$$\Rightarrow ? = \frac{7}{14}$$

$$\Rightarrow ? = \frac{1}{2}$$

$$\Rightarrow ? = 0.5$$

65. Ans. B.

By approximation, we get:

$$2730 \div 455 + \sqrt{961} + ?^2 = \sqrt{5329}$$

$$\Rightarrow 2730 \times \frac{1}{455} + 31 + ?^2 = 73$$

$$\Rightarrow 6 + 31 + ?^2 = 73$$

$$\Rightarrow ?^2 = 73 - 37 = 36$$

$$\Rightarrow ? = 6$$

66. Ans. A.

Let the male students applied for P.O, S.O and clerk be x, y and z respectively,

In addition, female students applied for P.O, S.O and clerk be a, b and c respectively.



SBI & IBPS 2022: A Sure Shot Success batch
(Batch 5)
Clear All SBI & IBPS 2022 Exams in First Attempt

START FREE TRIAL

Given conditions are

$$z = 3x \text{ ----- (I)}$$

$$y = 120 + x \text{ ----- (ii)}$$

$$x : a = 2 : 3 \text{ ----- (iii)}$$

$$b = c \text{ ----- (IV)}$$

$$x = 0.75c \text{ ----- (v)}$$

$$x + y + z + a + b + c = 1220 \text{ ----- (VI)}$$

By putting the values in terms of x from all the equations in equation (VI), we get,

$$x + 120 + x + 3x + 3x/2 + x/0.75 + x/0.75 = 1220$$

$$39x + 16x = 1100 \times 6$$

$$x = 120$$

Therefore,

$$y = 120 + x = 120 + 120 = 240$$

$$z = 3 \times 120 = 360$$

$$a = 3x/2 = 180$$

$$b = x/0.75 = 160$$

$$b = c = 160$$

Post for which students applied	Male students	Female students
P.O	120	180
S.O	240	160
Clerk	360	160
Total	720	500

Required answer = 360 + 160 = 520
67. Ans. C.

Let the male students applied for P.O, S.O and clerk be x, y and z respectively,

In addition, female students applied for P.O, S.O and clerk be a, b and c respectively.

Given conditions are

$$z = 3x \text{ ----- (I)}$$

$$y = 120 + x \text{ ----- (ii)}$$

$$x : a = 2 : 3 \text{ ----- (iii)}$$

$$b = c \text{ ----- (IV)}$$

$$x = 0.75c \text{ ----- (v)}$$

$$x + y + z + a + b + c = 1220 \text{ ----- (VI)}$$

By putting the values in terms of x from all the equations in equation (VI), we get,

$$x + 120 + x + 3x + 3x/2 + x/0.75 + x/0.75 = 1220$$

$$39x + 16x = 1100 \times 6$$

$$x = 120$$

Therefore,

$$y = 120 + x = 120 + 120 = 240$$

$$z = 3 \times 120 = 360$$

$$a = 3x/2 = 180$$

$$b = x/0.75 = 160$$

$$b = c = 160$$

Post for which students applied	Male students	Female students
P.O	120	180
S.O	240	160
Clerk	360	160
Total	720	500

Required ratio = 720 : 500 = 36 : 25
68. Ans. B.

Let the male students applied for P.O, S.O and clerk be x, y and z respectively,

In addition, female students applied for P.O, S.O and clerk be a, b and c respectively.

Given conditions are

$$z = 3x \text{ ----- (I)}$$

$$y = 120 + x \text{ ----- (ii)}$$

$$x : a = 2 : 3 \text{ ----- (iii)}$$

$$b = c \text{ ----- (IV)}$$

$$x = 0.75c \text{ ----- (v)}$$

$$x + y + z + a + b + c = 1220 \text{ ----- (VI)}$$



SBI & IBPS 2022: A Sure Shot Success batch
(Batch 5)
Clear All SBI & IBPS 2022 Exams in First Attempt

START FREE TRIAL

By putting the values in terms of x from all the equations in equation (VI), we get,

$$x + 120 + x + 3x + 3x/2 + x/0.75 + x/0.75 = 1220$$

$$39x + 16x = 1100 \times 6$$

$$x = 120$$

Therefore,

$$y = 120 + x = 120 + 120 = 240$$

$$z = 3 \times 120 = 360$$

$$a = 3x/2 = 180$$

$$b = x/0.75 = 160$$

$$b = c = 160$$

Post for which students applied	Male students	Female students
P.O	120	180
S.O	240	160
Clerk	360	160
Total	720	500

$$\text{Required answer} = \frac{400 - 300}{400} \times 100 = 25\%$$

69. Ans. D.

Let the male students applied for P.O, S.O and clerk be x, y and z respectively,

In addition, female students applied for P.O, S.O and clerk be a, b and c respectively.

Given conditions are

$$z = 3x \text{ ----- (I)}$$

$$y = 120 + x \text{ ----- (ii)}$$

$$x : a = 2 : 3 \text{ ----- (iii)}$$

$$b = c \text{ ----- (IV)}$$

$$x = 0.75c \text{ ----- (v)}$$

$$x + y + z + a + b + c = 1220 \text{ ----- (VI)}$$

----- (VI)

By putting the values in terms of x from all the equations in equation (VI), we get,

$$x + 120 + x + 3x + 3x/2 + x/0.75 + x/0.75 = 1220$$

$$39x + 16x = 1100 \times 6$$

$$x = 120$$

Therefore,

$$y = 120 + x = 120 + 120 = 240$$

$$z = 3 \times 120 = 360$$

$$a = 3x/2 = 180$$

$$b = x/0.75 = 160$$

$$b = c = 160$$

Post for which students applied	Male students	Female students
P.O	120	180
S.O	240	160
Clerk	360	160
Total	720	500

$$\text{Required answer} = \frac{480}{320} \times 100 = 150\%$$

70. Ans. D.

Let the male students applied for P.O, S.O and clerk be x, y and z respectively,

In addition, female students applied for P.O, S.O and clerk be a, b and c respectively.

Given conditions are

$$z = 3x \text{ ----- (I)}$$

$$y = 120 + x \text{ ----- (ii)}$$

$$x : a = 2 : 3 \text{ ----- (iii)}$$

$$b = c \text{ ----- (IV)}$$

$$x = 0.75c \text{ ----- (v)}$$

$$x + y + z + a + b + c = 1220 \text{ ----- (VI)}$$

----- (VI)



SBI & IBPS 2022: A Sure Shot Success batch
(Batch 5)
Clear All SBI & IBPS 2022 Exams in First Attempt

START FREE TRIAL

By putting the values in terms of x from all the equations in equation (VI), we get,

$$x + 120 + x + 3x + \frac{3x}{2} + \frac{x}{0.75} + \frac{x}{0.75} = 1220$$

$$39x + 16x = 1100 \times 6$$

$$x = 120$$

Therefore,

$$y = 120 + x = 120 + 120 = 240$$

$$z = 3 \times 120 = 360$$

$$a = \frac{3x}{2} = 180$$

$$b = \frac{x}{0.75} = 160$$

$$b = c = 160$$

Post for which students applied	Male students	Female students
P.O	120	180
S.O	240	160
Clerk	360	160
Total	720	500

$$\text{Required answer} = \frac{360-340}{360} \times 100 = 50/9\%$$

71. Ans. B.

Let the radius of circular field = r m

$$\text{Speed of person in m/s} = \frac{40}{60} = \frac{2}{3} \text{ m/s}$$

According to the question,

$$\frac{2\pi r}{2/3} - \frac{2r}{2/3} = 45 \Rightarrow 3\pi r - 3r = 45$$

$$\Rightarrow \left(\frac{22}{7} - 1\right)r = 15$$

$$\Rightarrow 15r = 105$$

$$\Rightarrow r = 7$$

72. Ans. E.

Let quantity of acid and alcohol in mixture A be 7x and 5x litres respectively

On addition of 18 liters of mixture B in mixture A:

$$\text{Quantity of alcohol added} = \frac{1}{3} \times 18 = 6 \text{ L}$$

$$\text{And quantity of acid added} = 18 - 6 = 12 \text{ L}$$

ATQ,

$$\frac{7x+12}{5x+6} = \frac{8}{5} \text{ (Since in final mixture, acid is 160\% of alcohol)}$$

$$\Rightarrow 35x + 60 = 40x + 48$$

$$\Rightarrow x = \frac{12}{5} = 2.4$$

$$\text{Hence volume of acid in mixture A} = 7 \times 2.4 = 16.8 \text{ L}$$

$$\text{Total volume of acid in final mixture} = 16.8 + 12 = 28.8 \text{ L}$$

73. Ans. B.

Let salaries of Anik, Bhuvan and Charlie be x, y and z respectively.

$$\frac{x+y}{2} = \frac{9}{2}$$

$$\Rightarrow 2x + 2y = 9x - 9y$$

$$\Rightarrow 7x = 11y \dots(1)$$

$$\Rightarrow x : y = 11 : 7$$

And,

$$\frac{y+z}{2} = \frac{9}{2}$$

$$\Rightarrow 2y + 2z = 9y - 9z$$

$$\Rightarrow 7y = 11z$$

$$\Rightarrow y : z = 11 : 7$$

$$\therefore x : y : z = 121 : 77 : 49$$

$$\therefore \text{Salary of Bhuvan} = \frac{77}{121 + 77 + 49} \times 494000$$

$$= \text{Rs. } 154000$$

74. Ans. C.

Milk and water in vessel A = 60liters and 40 liters

Milk and water in vessel B = 150 liters and 120 liters



SBI & IBPS 2022: A Sure Shot Success batch
(Batch 5)
Clear All SBI & IBPS 2022 Exams in First Attempt

START FREE TRIAL

When 30% of mixture is taken out from vessel A

Milk taken out = $30 \times \frac{3}{5} = 18$ liters

Water taken out = 12 liters

Milk and water in vessel B after 1st procedure

Milk = $150 + 18 = 168$ liters

Water = $120 + 12 = 132$

New ratio between milk and water in vessel B = $168 : 132 = 42 : 33$

Total mixture = 300 liters

When 50% percent is taken out from vessel B,

Milk taken out = $150 \times \frac{42}{75} = 84$ liters

Water taken out = $150 - 84 = 66$ liters

Now,

Milk in vessel A = $42 + 84 = 126$ liters

Water in vessel A = $28 + 66 = 94$ liters

Required ratio in vessel A = $126 : 94 = 63 : 47$

75. Ans. A.

Total number of characters in the book = $110 \times 32 \times 16 = 56320$ characters

Number of pages in another notebook = 44 pages

Number of lines on each page of another notebook = 20

Let the number of characters in each line of another notebook = x

According to the data provided in the question,

$$44 \times 20 \times x = 56320$$

$$\Rightarrow x = 64$$

Number of characters in each line of another Notebook = 64

$$\text{Required Percent} = \frac{64 - 16}{48} \times 100\% = \frac{48}{16} \times 100 = 300\%$$

76. Ans. A.

$$\text{Population of village A} = \frac{13}{100} \times 120 = 15.6 \text{ lakhs}$$

$$\text{Population of A above poverty line} = 15.6 \times \frac{55}{100} = 8.58 \text{ lakhs}$$

$$\text{Population of Village C above poverty line} = 120 \times \frac{8}{100} \times \frac{40}{100} = 3.84 \text{ lakhs}$$

$$\text{Required difference} = 8.58 - 3.84 = 4.74 \text{ lakhs}$$

77. Ans. C.

$$\text{Total population of village G} = \frac{9}{30} \times 100 = 30 \text{ lakhs}$$

$$15\% \text{ of the total population} = 30 \text{ lakhs}$$

$$\text{So, population of village E} = \frac{30}{15} \times 18 = 36 \text{ lakhs}$$

$$\text{Required difference} = \frac{2}{12} \times 36 = 6 \text{ lakhs}$$

78. Ans. D.

$$\text{Male population of village F in 2006} = \frac{10}{250} \times 100 = 4 \text{ lakhs}$$

$$\text{Total population of village F in 2006} = 4 \times 2 = 8 \text{ lakhs}$$

$$\text{So, number of people above poverty level in Village F in 2006} = 8 \times \frac{75}{100} = 6 \text{ lakhs}$$

79. Ans. C.



SBI & IBPS 2022: A Sure Shot Success batch
(Batch 5)
Clear All SBI & IBPS 2022 Exams in First Attempt

START FREE TRIAL

Total population of all the villages =
 $\frac{99}{(16 + 17)} \times 100 = 300$ lakhs

Female population in village A =
 $\frac{3}{5} \times \frac{13}{100} \times 300 = 23.4$ lakhs

Male population in village C =
 $\frac{5}{12} \times \frac{8}{100} \times 300 = 10$ lakhs

Required difference = $23.4 - 10 = 13.4$ lakhs

80. Ans. D.

Total population of Village G =
 $\frac{18}{30} \times 100 = 60$ lakhs

Total population of all the village =
 $\frac{60}{15} \times 100 = 400$ lakhs

Male population of village E =
 $400 \times \frac{18}{100} \times \frac{7}{12} = 42$ lakhs

Female population of village E =
 $400 \times \frac{18}{100} \times \frac{5}{12} = 30$ lakhs

Required difference = $42 - 30 = 12$ lakh

81. Ans. C.

Option A though mentioned previously in the passage is out of context with respect to the question asked. Option B is not mentioned in the passage; also it is a little impractical statement to be passed about the workings of a new and developing country. According to the last paragraph of passage it clearly shows, how countries on the perimeter of the network of global data flow benefits.

82. Ans. E.

The statement C can be found in the start of the passage, similarly Statement D is mentioned towards the end. Proper reading of the passage leads us to the fact that all the statements have been mentioned in the passage.

83. Ans. A.

The author in the passage mainly briefs about the new era of digitalization. Also it is known that the marginal costs of digital communications and transactions are near-zero. Option b is irrelevant. And option C is out of context.

84. Ans. D.

Option A is mentioned previously in the passage. Option B takes as a little off topic. Though it still talks about digitalization it takes a political point of view which over there is irrelevant. Option C also tells us about the disruptive effect of digitalization. Hence both the statement A and C are correct.

85. Ans. D.

Option A talks about innovations. In no angle does the passage focus on new innovations. Option B sounds like an opening statement but not the theme of the passage. Option C is a little vague. Where else option D precisely describes the central idea of the passage that is digital globalization and developing world.

86. Ans. C.

The meaning is mainstream would be typical; where else marrow is



used to refer to the core. Kernel is a kind of seed. The closest meaning of periphery - the outer limits or edge of an area or object is Boundary.

87. Ans. E.

Laggard - a person who makes slow progress and falls behind others. Option A and D are synonyms with laggard. Option B refers to someone who litters around. Option E is the correct choice as a workaholic is a person who is addicted to his work which makes it the opposite of laggard.

88. Ans. A.

In the given sentence, only 'unprecedented' make it grammatically as well as contextually correct.

Option A): is the correct alternative among the given choices as 'unprecedented' which means 'never done or known before' fit here both grammatically and contextually because after adjective 'unprecedented' we have the noun 'situation'.

Option B): is incorrect as fertile means (pertaining to soil or land) producing or capable of producing abundant vegetation or crops which does not make any sense here.

Option C): is incorrect as fatal means causing death.

Option D): is incorrect as ruinous means disastrous or destructive which does not fit here contextually.

89. Ans. B.

In the given sentence, only 'commodity' makes it grammatically as well as contextually correct.

Option A): is incorrect because fatigue means 'cause someone to feel exhausted'. It does not fit here both grammatically and contextually, as it is a verb.

Option B): is the correct alternative among the given answer choices. Commodity means 'useful or valuable thing'. It fits here both grammatically and contextually as after article 'a' we need a noun here.

Option C): is incorrect as vigorous means strong, healthy, and full of energy

Option D): is incorrect as exhaustion means a state of extreme physical or mental tiredness which does not fit here contextually.

90. Ans. D.

In the given sentence, only 'trend' make it grammatically as well as contextually correct.

Option A): is incorrect because corrupt means dishonest or fraudulent conduct by those in power, typically involving bribery which does not fit here.

Option B): is incorrect as venerable means accorded a great deal of respect, especially because of age, wisdom, or character which does not make any sense here as it is an adjective. So it does not fit here both grammatically and contextually.

Option C): is incorrect as 'animus' means hostility or ill feeling does not fit here.



SBI & IBPS 2022: A Sure Shot Success batch
(Batch 5)
Clear All SBI & IBPS 2022 Exams in First Attempt

START FREE TRIAL

Option D): is the correct alternative among the given answer choices. 'Trend' fits here both grammatically and contextually since it is a noun.

91. Ans. E.

In the given sentence, only 'frantically' makes it grammatically as well as contextually correct as it is an adverb that is followed by verb 'stockpiling'.

Option A): is incorrect because antagonism, which is also a noun, means 'active hostility or opposition'. It does not fit here.

Option B): is incorrect as enmity means 'a state or feeling of active opposition or hostility'. It does not make any sense here.

Option C): is incorrect as 'amity' means 'friendly relations'. It does not fit here.

Option D): is incorrect as puritanical means 'having or displaying a very strict or censorious moral attitude towards self-indulgence or sex'. It does not fit here contextually.

92. Ans. D.

In the given sentence, only 'dwindling' makes it grammatically as well as contextually correct.

Option A): is incorrect because austerity means 'sternness or severity of manner or attitude'. It does not fit here.

Option B): is incorrect as lenient means 'of a punishment or person in authority more merciful or tolerant than expected'. It does not make any sense here.

Option C): is incorrect as 'behest' means a person's orders or

command. It does not fit in the given blank.

Option D): is the correct alternative among the given answer choices as 'dwindling' means 'gradually diminishing in size, amount, or strength'. It fits the given blank both grammatically and contextually.

93. Ans. D.

In the given sentence, only 'obsession' makes it grammatically as well as contextually correct.

Option A): is incorrect because irenic which means 'aiming or aimed at peace' does not fit here.

Option B): is incorrect as provocative means 'causing anger or another strong reaction, especially deliberately'. It does not make any sense here also it is an adjective.

Option C): is incorrect as 'dispensation' which means 'exemption from a rule or usual requirement' does not fit here.

Option D): is the correct alternative among the given choices. 'Obsession' which is a noun, means 'the state of being obsessed with someone or something'. It fits here both grammatically and contextually.

94. Ans. A.

In the given sentence, only 'dusted off' makes it grammatically as well as contextually correct.

Option A) is the correct alternative among the given answer choices. 'Dusted off' means 'to bring out or back to use again'. It perfectly fits



SBI & IBPS 2022: A Sure Shot Success batch
(Batch 5)
Clear All SBI & IBPS 2022 Exams in First Attempt

START FREE TRIAL

in the blank both grammatically and contextually. Since the sentence is in passive voice, we should use past participle form of the verb.

Option B) is incorrect as disparate means 'essentially different in kind; not able to be compared'. It does not make any sense here and it is an adjective but in the blank position we need a verb. So, it gets opted out.

Option C) is incorrect because 'adduce' means 'cite as evidence'.

Option D) is incorrect because 'lineage' means 'direct descent from an ancestor; ancestry or pedigree'. It is both grammatically and contextually wrong.

95. Ans. A.

The passage states that India must seize the opportunity to create safe and healthy workplace. B and A are mandatory pairs as the latter presents the contrast of the former. Note that the sixth sentence is the last statement, which makes it easy to find the fifth statement. (6) mentions that even in countries which have organised data collection systems, accidents and diseases are common. So, the preceding sentence must talk about the existence of diseases where the data collection systems are not organised. Since the different surveys in India show varying data, India can be said to lack an organised data collection system. So, A must precede (6). Thus, the latter part of the sequence is BA6.

Now let us find the first statement. It must majorly introduce the idea of the whole passage. C establishes the subject of the passage i.e. occupational and work-related deaths. E follows C. So the first two sentences are C and E. D and B form a mandatory pair as D talks about available government statistics and B gives out those statistics.

Since the first two sentences are C and E and the last two are B and A, would follow E. So, the correct sequence after rearrangement is CEDBA.

The fifth sentence after rearrangement is A.

96. Ans. C.

In order to find out the statement that precedes the fifth statement, we will have to find out the fifth statement. For this, let us again identify the fifth statement. As discussed in the solution of the first question, the fifth sentence is A. It provides details about the scientific research article, which contrasts the statistics of the government. So, a preceding sentence can talk about the same. Option C states, that the government statistics do not cover unregistered mines and factories. So, only (C) can logically precede statement (A).

(A) and (D) talk about "Occupational Safety and Health", which is a separate discussion altogether. (B) can be eliminated as it cannot be contextually linked with the fifth sentence.



SBI & IBPS 2022: A Sure Shot Success batch
(Batch 5)
Clear All SBI & IBPS 2022 Exams in First Attempt

START FREE TRIAL

97. Ans. D.

The passage states that India must seize the opportunity to create safe and healthy workplace. B and A are mandatory pairs as the latter presents the contrast of the former. Note that the sixth sentence is the last statement, which makes it easy to find the fifth statement. (6) mentions that even in countries which have organised data collection systems, accidents and diseases are common. So, the preceding sentence must talk about the existence of diseases where the data collection systems are not organised. Since the different surveys in India show varying data, India can be said to lack an organised data collection system. So, A must precede (6). Thus, the latter part of the sequence is BA6. Now let us find the first statement. It must majorly introduce the idea of the whole passage. C establishes the subject of the passage i.e. occupational and work-related deaths. E follows C. So the first two sentences are C and E. D and B form a mandatory pair as D talks about available government statistics and B gives out those statistics. Since the first two sentences are C and E and the last two are B and A, would follow E. So, the correct sequence after rearrangement is CEDBA. Hence, B-A make is a mandatory pair.

98. Ans. D.

The passage talks about the diseases that are chronic ailments caused as a result of work or occupational activity. Thus, no other word but occupational will fit in the blank.

99. Ans. A.

The passage states that India must seize the opportunity to create safe and healthy workplace. B and A are mandatory pairs as the latter presents the contrast of the former. Note that the sixth sentence is the last statement, which makes it easy to find the fifth statement. (6) mentions that even in countries which have organised data collection systems, accidents and diseases are common. So, the preceding sentence must talk about the existence of diseases where the data collection systems are not organised. Since the different surveys in India show varying data, India can be said to lack an organised data collection system. So, A must precede (6). Thus, the latter part of the sequence is BA6. Now let us find the first statement. It must majorly introduce the idea of the whole passage. C establishes the subject of the passage i.e. occupational and work-related deaths. E follows C. So the first two sentences are C and E. D and B form a mandatory pair as D talks about available government statistics and B gives out those statistics. Since the first two sentences are C and E and the last two are B and A,



SBI & IBPS 2022: A Sure Shot Success batch
(Batch 5)
Clear All SBI & IBPS 2022 Exams in First Attempt

START FREE TRIAL

would follow E. So, the correct sequence after rearrangement is CEDBA.

Thus, the fourth statement after rearrangement is B.

100. Ans. E.

There is no grammatical error in the sentence and it is meaningful contextually as well. Thus, option E is the correct answer.

101. Ans. B.

The error in second part of the given sentence, the word 'by' is a preposition which should be replaced with 'to' make it grammatically and contextually correct. Other than this there is no error.

Therefore, option B is the correct answer choice to this question.

102. Ans. C.

The error is in the third part of the sentence, here conjunction is missing which joins group of words showing connection between them. We need to use 'and' between 'Rural development' and 'Panchayati Raj' to link them. This replacement makes the sentence grammatically and contextually correct. Other than this there is no error.

Therefore, option C is the correct answer choice to this question.

103. Ans. D.

When we talking about the gross collection of any movie, we talk about numbers and figures in the form of data interpretation methods (bar graphs, line graphs, etc.). The higher the peak of these graphs, higher is the collection figure. That

is why we say highest grossing and not largest grossing. Hence, the correct answer is D.

104. Ans. C.

Since the sentence is in the past tense (were peaceful), the emboldened part also needs to be in the past tense, with the verb 'resort' changed to 'resorted'.

Thus, option C is the correct answer.

105. Ans. D.

Since the sentence is in the simple past tense (surged), the verb 'hitting' needs to be changed to 'hit' to maintain the tone of the sentence.

Thus, option D is the correct answer.

106. Ans. C.

The error in the emboldened segment lies in the usage of the preposition 'among' to denote a position between two things. 'Between' is used when objects in question are two in number. For numbers greater than two, it is customary to use 'among'. Thus, statement II will be an apt replacement.

So far as statement III is concerned, since 'amidst' essentially means in the middle of something, it is contextually fitting. Thus, option C is the correct answer.

107. Ans. D.

We use "primarily" to express order of importance.

If we consider sentence III to be the base sentence, we can add



SBI & IBPS 2022: A Sure Shot Success batch
(Batch 5)
Clear All SBI & IBPS 2022 Exams in First Attempt

START FREE TRIAL

sentence I to it as it is more important than sentence II. Sentence II comes at the end to emphasize on the order.

New Sentence: Indian economy is dependent on the agricultural sector as it primarily earns from agricultural activities than industrial activities.

Hence, option D is the correct answer.

108. Ans. E.

The first sentence talks about a couple travelling on metro. The second sentence describes how the train was.

Although, all three given phrases are related to the topics covered in the sentences, they cannot be used to join the two sentences to produce a single conceptually and grammatically correct sentence.

Hence the correct answer is option E.

109. Ans. A.

'To make a long story short' is to tell something briefly or concisely. As such, the idiom makes contextual sense only in statement I.

In statement II, a more appropriate idiom will be 'on the ball', meaning doing a good job.

In statement III, a more appropriate idiom will be 'go back to the drawing board', which means beginning something all over again.

110. Ans. B.

To 'hang in there' is to not give up on something. As such, the idiom fit statements I and III accurately.

In statement II, a more appropriate idiom will be to 'hit the sack', meaning to go to sleep.

111. Ans. D.

India-China bilateral trade in 2021 increased by 43.31% year on year to reach US\$ 125.62 billion.

India's exports to China increased by 34.28% year on year to reach US\$28.03 billion.

India's imports from China witnessed an increase of 46.14% to reach US\$97.59 billion.

The trade deficit is US\$ 69.56 billion, increasing by 51.53% year on year.

112. Ans. E.

11th edition of Rashtriya Sanskriti Mahotsav 2022 started at Arts College Ground Rajamahendravaram, Andhra Pradesh.

The second leg of the Rashtriya Sanskriti Mahotsav 2022 event was held in Warangal, was inaugurated by the Telangana governor, Tamilsai Soundararajan.

113. Ans. A.

A leading private general insurer, HDFC ERGO General Insurance Company, has launched the industry's first digital reward program.

VAULT program leads the way in customer loyalty.

It is the industry's first digital customer engagement and rewards program.

114. Ans. C.

* Pradhan Mantri Suraksha Bima Yojana was launched in 2015



SBI & IBPS 2022: A Sure Shot Success batch
(Batch 5)
Clear All SBI & IBPS 2022 Exams in First Attempt

START FREE TRIAL

* It is a one-year accidental death and disability cover which could be renewed annually.

115. Ans. D.

* YONO (You Only Need One) is an integrated digital banking platform offered by State Bank of India (SBI) to enable users to access a variety of financial and other services such as flight, train, bus and taxi bookings, online shopping, or medical bill payments.

116. Ans. B.

The Hurun Global Forty and Under Self-Made Billionaires 2022 report released by Hurun Research Institute, ranks the self-made billionaires in the world (in terms of US dollars) under 40.

According to the report, the USA (37 billionaires), China (25 billionaires), followed by the UK (8), India (6) and Sweden (3) respectively in the top five.

117. Ans. E.

The Cabinet committee led by PM Narendra Modi approved USD 808 million (₹6,062.45 crores) for a new World Bank-assisted scheme named Raising and Accelerating MSME Performance (RAMP).

The new scheme is expected to commence in financial 2022-23.

Out of the total amount, \$ 500 million would be a loan from the World Bank, and the remaining amount of \$ 308 million will be funded by the government of India.

118. Ans. B.

* Eight core sectors are Coal, crude oil, natural gas, refinery products,

fertiliser, steel, cement and electricity.

* These comprise 40.27% of the weight of items included in the Index of Industrial Production (IIP).

* The eight core sector industries in decreasing order of their weightage: Refinery Products > Electricity > Steel > Coal > Crude Oil > Natural Gas > Cement > Fertilizers.

* The output of Eight Core Industries grew at 3.1 %, the slowest pace in eight months in November, indicating slowing momentum in the Indian economy. Barring crude oil and cement, all other sectors recorded positive growth.

119. Ans. C.

DBS Bank India collaborate with EaseMyTrip to launch the Green international debit card.

This card is made using 99% recycled polyvinyl chloride (PVC) material.

Green Debit Card provides exclusive travel-related offers and rewards to customers for adopting eco-friendly practices.

120. Ans. A.

* Ude Desh Ka Aam Naagrik (UDAN) was launched as a Regional Connectivity Scheme (RCS) under the Ministry of Civil Aviation in 2016.



SBI & IBPS 2022: A Sure Shot Success batch
(Batch 5)
Clear All SBI & IBPS 2022 Exams in First Attempt

START FREE TRIAL

* It provides connectivity to unserved and underserved airports of the country through the revival of existing air-strips and airports.

121. Ans. B.

RBI Governor Shaktikanta Das has set up the Ink Manufacturing Unit named, Varnika under Bharatiya Reserve Bank Note Mudran Private Limited (BRBNMPL), a wholly owned subsidiary of RBI in Mysuru.

Varnika has an annual ink manufacturing capacity of 1,500 MT, which helps to enhance the security of banknotes.

This unit will also manufacture Colour Shift Intaglio Ink (CSII)

122. Ans. D.

- The Ministry of Education (MoE) on Wednesday approved a new scheme "New India Literacy Programme" for the next five years to cover all the aspects of adult education to align with the new National Education Policy (NEP).

- The ministry has also decided to use "Education For All" instead of "Adult Education" as the previous term did not appropriately represent all non-literates in the 15 years and above age group.

- The scheme will be implemented through volunteerism via online mode. The training, orientation, workshops of volunteers, maybe organized through face-to-face mode.

- The scheme will cover non-literates of the age of 15 years and above in all state and union territories.

123. Ans. C.

- * Budget 2022-23 proposes to expand guarantee cover under ECLGS by Rs 50000 Crore to total cover of Rs 5 Lakh Crore.

124. Ans. D.

- The process of Air India disinvestment got completed with the government officially handing over the management control of the airlines to Talace Private Limited, a subsidiary of the Tata Group's holding company.

- The total value of the deal is Rs 18,000 crore (US\$2.4 billion).

- The strategic disinvestment transaction of Air India includes transfer of 100 percent stake of GoI in Air India to Tata Sons, along with management control.

- The transaction covers three entities namely, Air India, Air India Express and Air India SATS (AI SATS).

- Under the deal, Tata group will also be handed over Air India Express and 50 percent stake in ground handling arm AI SATS.

125. Ans. C.

PM Narendra Modi participated in the 5th BIMSTEC (Bay of Bengal Initiative for Multi-Sectoral Technical and Economic Cooperation) Summit which was hosted by Sri Lanka, the current chair of BIMSTEC virtually.

The theme was Towards a Resilient Region, Prosperous Economies, Healthy People.



SBI & IBPS 2022: A Sure Shot Success batch
(Batch 5)
Clear All SBI & IBPS 2022 Exams in First Attempt

START FREE TRIAL

126. Ans. B.

Kotak Mahindra Bank and Axis Bank each has acquired 7.84% stake in Open Network Digital Commerce (ONDC) for ₹ 10 crore.

This network develops and transform the Indian digital commerce ecosystem for both goods and services.

It is an initiative of the Department for Promotion of Industry and Internal Trade (DPIIT) under the Ministry of Commerce and Industry.

127. Ans. C.

* Advance estimates suggest that the GVA of Industry (including mining and construction) will rise by 11.8 per cent in 2021-22 after contracting by 7 per cent in 2020-21.

* The Services sector has been the hardest hit by the pandemic, especially segments that involve human contact. This sector is estimated to grow by 8.2 per cent this financial year following last year's 8.4 per cent contraction.

* Despite all the disruptions caused by the global pandemic, India's balance of payments remained in surplus throughout the last two years. This allowed the Reserve Bank of India to keep accumulating foreign exchange reserves (they stood at US\$ 634 billion on 31st December 2021).

* This is equivalent to 13.2 months of merchandise imports and is

higher than the country's external debt.

128. Ans. C.

* Former union minister and Lok Sabha Member of Parliament Dr Shashi Tharoor's 23rd book titled 'Pride, Prejudice and Punditry' was launched in Hyderabad, Telangana.

* The book, published by Aleph Book Company, was earlier launched in Delhi.

* There are ten sections in this book, each devoted to a particular topic such as modern Indian history, Indian Politics etc.

129. Ans. C.

• The government is setting up the National Land Monetisation Corporation with an initial authorized share capital of ₹5000 crores and subscribed share capital of ₹150 crores, to carry out the monetization of the land and other non-core assets.

• So far, CPSEs have referred 3,400 acres of land and other non-core assets for monetisation from CPSEs including MTNL, BSNL, BPCL, B&R, BEML, HMT Ltd, Instrumentation Ltd.

• Top five sectors including roads, railways, power, oil and gas pipelines and telecom account for around 83 per cent of the aggregate value.

130. Ans. C.

The birth anniversary of Dutch painter Vincent Van Gogh's observed as World Bipolar Day on March 30 every year.



SBI & IBPS 2022: A Sure Shot Success batch
(Batch 5)
Clear All SBI & IBPS 2022 Exams in First Attempt

START FREE TRIAL

The theme of World Bipolar Day 2022 is Bipolar Together.

March 27 observed a World Theatre Day

131. Ans. A.

- Tata Motors will be the sponsor of the Tata Open Maharashtra tennis tournament for the fourth consecutive year.

- The tournament, scheduled from 31 January to 6 February at the Balewadi stadium.

- It is South Asia's only ATP (Association of Tennis Professionals) tournament and India's oldest international sporting event.

- The fourth edition of the tournament is all set to make its return after a one-year break due to the pandemic.

132. Ans. E.

- Dharendra K. Jha, a Delhi based journalist, has authored a new book titled "Gandhi's Assassin: The Making of Nathuram Godse and His Idea of India".

- The book is published by Vintage Books.

- The book explores Godse's relationship with the organizations that influenced his view and gave him a sense of purpose and draws out the gradual hardening of Godse's resolve that led to Mahatma Gandhi's assassination.

133. Ans. D.

- Securities and Exchange Board of India (SEBI) has reconstituted 20-members alternative investment policy advisory committee.

- Chairman of the committee: N R Narayana Murthy.

- It will advise the capital markets regulator on a range of issues that impact further development of AIF (Alternative Investment Fund) industry.

- Prior to this, there were 22 members in the committee, which was constituted in March 2015.

134. Ans. C.

- * MIBOR is the acronym for Mumbai Interbank Offer Rate, the yardstick of the Indian call money market. It is the rate at which banks borrow unsecured funds from one another in the interbank market.

- * The same was rechristened as FIMMDA-NSE MIBID/MIBOR rate in due course.

135. Ans. A.

Pritam Siwach Hockey Academy, Sonapat, clinched the title of Khelo India Women's Hockey League (U-21) after defeating Sports Hostel Bhubaneswar by 5-0 in the final at the Sports Authority of India National Centre of Excellence in Lucknow.

The Sonapat-based academy is run by the former captain of the India women's hockey team Pritam Rani Siwach; she is also won the Dronacharya Award winner in 2021.

136. Ans. D.

- * Union Budget 2022-23 has proposed the launch of Raising and Accelerating MSME performance (RAMP) programme in coming 5 years to boost MSME sector.



SBI & IBPS 2022: A Sure Shot Success batch
(Batch 5)
Clear All SBI & IBPS 2022 Exams in First Attempt

START FREE TRIAL

* The RAMP programme is the second intervention by the World Bank for the MSME sector.

137. Ans. C.

* RBI governor Shaktikanta Das inaugurated the Reserve Bank Innovation Hub (RBIH) in Bengaluru.

* The RBI has set up the RBIH as a Section 8 under Companies Act, 2013.

* RBIH is a wholly owned subsidiary of RBI with an initial capital contribution of ₹100 crore.

138. Ans. C.

• The Asian Infrastructure Investment Bank (AIIB), a multilateral development bank, will spend \$150 million in the creation of data centres that will primarily serve emerging Asia.

• This project is being AIIB's 1st data centre project.

• The Keppel Data Centre Fund II (KDCF II), a private equity company managed by Alpha Investment Partners Limited (Alpha), will route funds through the Beijing-based AIIB, of which India is a significant founding member.

139. Ans. A.

* Army Chief Gen MM Naravane announced setting up of a 'Chair of Excellence' in memory of India's first Chief of Defence Staff Gen Bipin Rawat at the United Service Institution of India (USI).

140. Ans. A.

• Pradhan Mantri MUDRA Yojana provides loans upto 10 lakh to the non-corporate, non-farm

small/micro enterprises. These loans are classified as MUDRA loans under PMMY.

• These loans are given by Commercial Banks, RRBs, Small Finance Banks, Cooperative Banks, MFIs and NBFCs.

• Under the aegis of PMMY, MUDRA has created three products namely 'Shishu', 'Kishore' and 'Tarun' to signify the stage of growth / development and funding needs of the beneficiary micro unit.

141. Ans. B.

Maharashtra won the 21st National Para-Swimming Championship 2022 with 306 points at the Maharana Pratap Khel Gaon, Udaipur.

The tournament was jointly organised by the Paralympic Committee of India (PCI) and Narayan Seva Sansthan.

142. Ans. C.

• The Ministry of Education's innovation cell released the Atal Ranking of Institutions on Innovation Achievements (ARIIA) 2021.

• ARIIA 2021 classifies participating institutions into two major categories; technical and non-technical.

• In the technical ranking, the Indian Institute of Technology Madras (IIT Madras) has been recognised as the Most Innovative Educational Institute in India.

• This is the third time that IIT Madras has secured the first rank.



SBI & IBPS 2022: A Sure Shot Success batch
(Batch 5)
Clear All SBI & IBPS 2022 Exams in First Attempt

START FREE TRIAL

- IIT Bombay and IIT Delhi were placed at the second and third ranks respectively.

143. Ans. B.

- * Bank of Baroda has signed a Memorandum of Understanding (MoU) with Assam Rifles to provide 'Central Forces Salary Package'.

- * Under the agreement, Bank of Baroda will offer the Baroda Central Forces Salary Package to all personnel of the Assam Rifles, both serving and retired.

- * Further, the Bank will also provide special benefits, including Personal Accident Insurance and a co-branded credit card.

- * Assam Rifles is country's oldest paramilitary force.

144. Ans. B.

- Payment Banks are registered as public limited company under the Companies Act, 2013.

- Payment Banks are licensed under Section 22 of the Banking Regulation Act, 1949, with specific licensing conditions restricting its activities to acceptance of demand deposits and provision of payments and remittance services.

145. Ans. D.

- Apple has retained its position as the most valuable brand in 2022 as well, according to the Brand Finance 2022 Global 500 report.

- The brand valuation of Apple was recorded at \$355.1 billion in 2022, which is an increase of 35% from last year.

- This is the highest brand value ever recorded in the Brand Finance Global 500 ranking history.

- Brands in the top 10

1. Apple

2. Amazon,

3. Google,

4. Microsoft,

5. Walmart,

6. Samsung,

7. Facebook,

8. Industrial and Commercial Bank of China,

9. Huawei

10. Verizon

146. Ans. B.

Red Bull's Max Verstappen won the title of F1 Saudi Arabian Grand Prix 2022 at Jeddah Corniche Circuit, Saudi Arabia.

This is the 21st title of his career.

He defeated Ferrari's Charles Leclerc, who placed in the second position.

147. Ans. B.

- * The RBI's Digital Payment Index, which shows the deepening of payments through digital modes in India, rose by 39.64 per cent to 304.06 in September 2021 against 217.74 in the year-ago month.

- * Constructed with March 2018 as the base period — DPI score for March 2018 is set at 100 — the RBI-DPI was 173.49 in September 2019.

- * The Index captures the extent of digitisation of payments across the country.

- * As per latest RBI data, the total volume of digital payments rose about 57.50 per cent year-on-year



SBI & IBPS 2022: A Sure Shot Success batch
(Batch 5)

Clear All SBI & IBPS 2022 Exams in First Attempt

START FREE TRIAL

to 645.84 crore in November 2021 against 410.07 crore in November 2020.

* The total value of digital payments was up 32 per cent y-o-y to ₹1,48,03,884 crore in November 2021 against ₹1,11,99,549 crore in November 2020.

148. Ans. A.

* India has overtaken the UK to rank third with 54 unicorns, according to Hurun Global Unicorn Index 2021.

* The report, released shows that Bengaluru has more unicorns than cities like Boston, Palo Alto, Paris, Berlin, Chicago among others, with a tally of 28 such companies--the seventh-highest in the world.

* India has more than doubled the number of unicorns from last year and overtook the UK in the tally.

* According to Hurun India, India's list of unicorns is led by edtech platform BYJU's which is valued at \$21 billion, followed by mobile ad-tech platform InMobi valued at \$12 billion and hospitality major OYO Rooms with a valuation of \$9.5 billion.

* In the e-commerce sector, India is the third-largest, only behind the US and China.

149. Ans. B.

• Securities and Exchange Board of India (SEBI) has launched Saa ₹thi mobile app on investor education.

• It will create awareness among the investors about the basic concepts of securities market, KYC

process, trading and settlement, mutual funds, etc.

• The app is available in Hindi and English.

150. Ans. C.

Belgian footballer Miguel Van Damme passed away following a long-running battle with leukaemia. He was diagnosed with leukaemia in 2016.

151. Ans. C.

Ministry of Environment, Forest, and Climate Change appointed Dr Renu Singh as the next director of the Forest Research Institute (FRI) in Dehradun.

She will be the second woman director of Forest Research Institute.

She is an officer of the IFS of the 1990 batch of Madhya Pradesh cadre.

152. Ans. A.

• The top-10 most valued companies suffered a combined erosion of Rs 2.53 lakh cr in market valuation last week.

• This is due to the domestic equity benchmarks witnessed heavy selling in line with the global market.

• Benchmark indices witnessed nearly a 4% cut last week as FPIs booked profits across large-caps and select mid-caps.

• The top-10 firms are Reliance Industries, TCS, HDFC Bank, Infosys, ICICI Bank, Hindustan Unilever, HDFC, SBI, Bajaj Finance and Bharti Airtel respectively.



SBI & IBPS 2022: A Sure Shot Success batch
(Batch 5)
Clear All SBI & IBPS 2022 Exams in First Attempt

START FREE TRIAL

153. Ans. C.

- First Digital Water Bank of India 'AQVERIUM' has been launched in Bengaluru, which is an innovative initiative aimed at better water management
- It is formed by AquaKraft Group Ventures.
- It is a very unique innovation combining sustainable & green technologies along with information technology, skill development & entrepreneurship.
- It is a curated list of water data from all institutions and sources, that will help tackle some common development challenges.

154. Ans. C.

- * 'Financial Stability Report (FSR)' is a flagship report released by the Reserve Bank of India on half-yearly basis.
- * The RBI Financial Stability Report (FSR) has identified some key macro risks to the Indian economy and the markets.
- * These macro risks arise from the global economic situation, the domestic situation and the structure of the market and the banking system.
- * The recent edition of the report was released by RBI.
- * As per the report, the retail-led credit growth model in India is beginning to face issues due to two factors, increase in defaults in the consumer finance portfolio and slowdown in the new credit segment.

155. Ans. B.

- * Small Industries Development Bank of India (SIDBI), the principal financial institution engaged in the promotion, financing and development of Micro, Small and Medium Enterprises (MSMEs), has launched SHWAS and AROG to help the MSMEs with required financial support.
 - * SHWAS is SIDBI assistance to the Healthcare sector in War Against Second wave of COVID19 and AROG is SIDBI Assistance to MSMEs for Recovery & Organic Growth during COVID19 pandemic, two new quick credit delivery schemes.
 - * The schemes are devised under the guidance from Government of India (GoI) which facilitates funding for production and services related to supply of oxygen cylinders, oxygen concentrators, oximeters and essential drugs.
156. Ans. E.
- The Reserve Bank of India, RBI has laid down eligibility norms for entities tapping into data from credit information companies (CICs), or credit bureaus.
 - The rules said that a company must be owned and controlled by resident Indian citizens to become a specified user with a credit bureau, amid reports of lending apps with Chinese links operating in India.
 - In order to be eligible as a 'specified user' under the Credit Information Companies (Amendment) Regulations, 2021, an entity must be a company



SBI & IBPS 2022: A Sure Shot Success batch
(Batch 5)
Clear All SBI & IBPS 2022 Exams in First Attempt

START FREE TRIAL

incorporated in India or a statutory corporation established in India.

- It added that in the case of a company, it should have a net worth of not less than 2 crore rupees as per the latest audited balance sheet, and shall meet the requirement on a continuing basis.

157. Ans. A.

- * UCO Bank in partnership with the National Payments Corporation of India (NPCI) launched the 'UCO Bank RuPay Select Contactless Debit Card' with a host of benefits for its premium/HNI (High Networth Individuals) customers.

- * This launch was made on the occasion of the 79th Inauguration Day of the bank i.e. January 6, 2022.

- * The card offers an ATM (Automated Teller Machine) withdrawal limit of Rs 50000 along with a purchase of up to Rs 2 lakh at POS (Point of Sale) or E-Commerce.

- * All RuPay Select Contactless Debit cardholders are eligible for the Insurance cover of up to Rs 10 lakhs (Death due to personal accident and permanent disability).

- * Two free domestic lounge access per quarter. Also, free access across more than 25 airports lounges in 15 cities

- * Two free international lounge access per annum. Access to more than 500 lounges in 300+ cities.

158. Ans. D.

Darrah National Park is in Rajasthan.

- Galathea, Mahatma Gandhi Marine and Mount Harriet National Parks are in Andaman and Nicobar.

- Mount Harriet National Park is an important bird area as attributed by Birdlife International

- New species frog named Rana Charles Darwin also found in Mount Harriet National Park.

159. Ans. C.

- The International Monetary Fund (IMF) has cut India's economic growth forecast for the current fiscal 2021-22 (FY22) to 9 percent, in its latest world economic outlook report, released on January 25, 2022.

- Earlier this was estimated at 9.5%

- IMF has projected the growth forecast for India in 2022-23 (FY23) at 7.1%

- IMF has projected the global growth rate in 2022 to 4.4%, and in 2023 to 3.8%.

160. Ans. D.

- * Paisabazaar.com partnered with Axis Bank to launch a pre-qualified program for unsecured loans on its platform.

- * Axis Bank customers, both salaried and self-employed, who are eligible for pre-qualified personal loans from the bank, will now be able to view and apply for the same offers through the Paisabazaar platform as well.

- * This integration would lead to instant access to credit for these select customers through an end-to-end digital process.



SBI & IBPS 2022: A Sure Shot Success batch
(Batch 5)
Clear All SBI & IBPS 2022 Exams in First Attempt

START FREE TRIAL

SBI & IBPS 2022: A Sure Shot Success batch (Batch 5)

Clear All SBI & IBPS 2022 Exams in First Attempt

- 200+ Live Classes
- 40+ Full-length Mock Tests
- 200+ Interactive Quizzes
- Coverage of Reasoning, QA, GA, Computer Knowledge & English

