

# Alphabet Test Tricks & Questions

## Alphabet Test

### Reasoning Alphabet Tricks

The question asked is based on finding an English letter to the left or right of another English letter in alphabetical order. Sometimes the Question is based on finding the number of English letter(s) between two different English letters.

This type of question varies on the arrangement of alphabetical order. For example, it can be Backward, first half backward, second half backward, multiple letter segments in changed order etc. Some of the questions asked are based on finding the middle letter of two specified letters, and in some questions, it is asked which letters do not change their place after alphabet arrangement.

So, the detailed explanation with examples is as follows:

#### 1. Place a letter in forward order

In this type of question, the exact letter has to be found out with the help of the direction of the question. The example discussed below will give you a better idea about this type of question.

**Ex 1: Find the 11<sup>th</sup> letter to the left of the 20<sup>th</sup> letter from the left in the English alphabet.**

- A. D
- B. J
- C. K
- D. I

**Solution: (D)**

Let us see

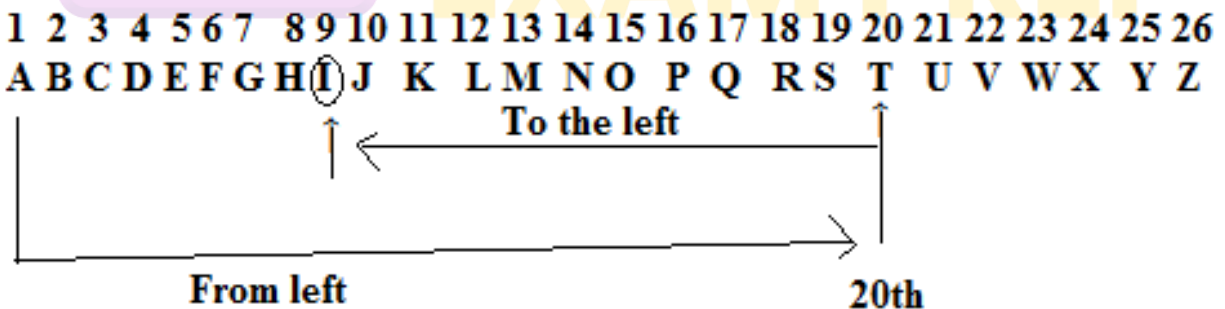

Hence, the 11<sup>th</sup> letter to the left of the 20<sup>th</sup> letter from the left is I.

#### Alternate Method

In the English alphabet, 11<sup>th</sup> letter to the left of 20<sup>th</sup> letter of your left =  $(20 - 11)$  th letter from the left = 9<sup>th</sup> letter from the left = I

#### 2. Place Of Letter in Completely Backward Order

In such questions, the order of letters is completely reversed, or they are counted from Z to A, and then the place of the letter is asked with the help of direction.



**Ex 2: If the English alphabet is written in backward order, then what will be the 13<sup>th</sup> letter to the left of the 3<sup>rd</sup> letter from right?**

- A. P
- B. N
- C. R
- D. Q

**Solution: (A)**

Backward order is written as

1 2 3 4 5 6 7 8 9 10 11 12 13 14 15 16 17 18 19 20 21 22 23 24 25 26  
 Z Y X W V U T S R Q (P) O N M L K J I H G F E D C B A



Now, the 13<sup>th</sup> letter to the left of the 3<sup>rd</sup> letter from the right is P.

**Alternate Method**

In backward order of the alphabet, 13<sup>th</sup> letter to the left of the 3<sup>rd</sup> letter of your right = (3+13)<sup>th</sup> letter from right = 16<sup>th</sup> letter from right P.

**3. Place of a Letter When First Half is in Backward Order**

In such type of question, only the 1<sup>st</sup> half of the order of alphabetical series is reversed. The remaining are left unaltered, i.e., the order of A to M is reversed, and then questions related to the latter's position are asked.

**Ex 3: If 1<sup>st</sup> half of the English alphabet is written in backward order, what will be the 7<sup>th</sup> letter to the left the 10<sup>th</sup> letter from your right?**

- A. C
- B. E
- C. D
- D. J

**Solution: (C)**

Let us see

13 12 11 10 9 8 7 6 5 4 3 2 1 14 15 16 17 18 19 20 21 22 23 24 25 26  
 M L K J I H G F E (D) C B A N O P Q R S T U V W X Y Z

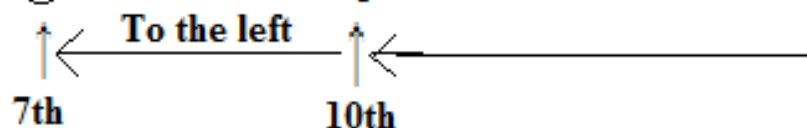

The 7<sup>th</sup> letter to the left of the 10<sup>th</sup> letter from our right is D.

**4. Place of a Letter When Second Half is in Backward Order**

In such types of questions, the 2<sup>nd</sup> half is reversed, i.e., from N to Z and remaining are kept as it is, and then questions related to the place of the English alphabet are asked.



**Ex 4: If 2<sup>nd</sup> half of the English alphabet is written in backward order, what will be the 7<sup>th</sup> letter to the right of the 13<sup>th</sup> letter from your left?**

- A. T
- B. U
- C. V
- D. S

**Solution: (A)**

Let us see

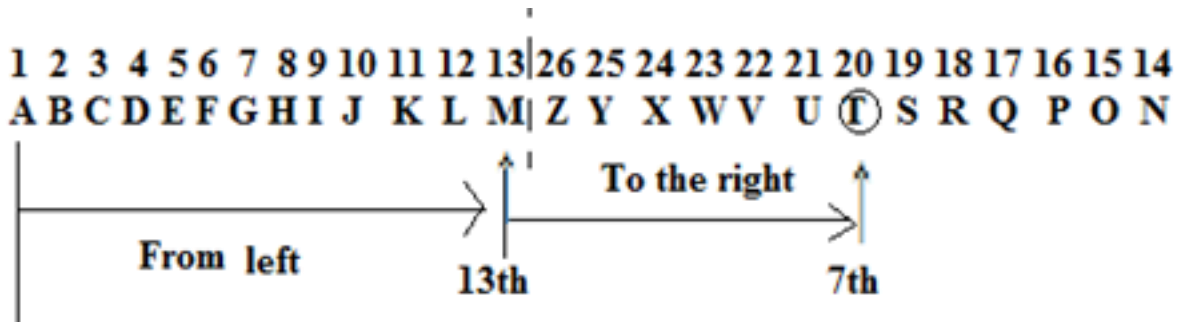

The 7<sup>th</sup> letter to the right of the 13<sup>th</sup> letter from our left is T.

**5. Multiple Letter Segment in Backward Order**

In such types of questions, no specified order of change is followed in alphabetical order. Instead, they are changed according to the condition given in a particular question.

**Ex 5: If the first four letters of the English alphabet are written in reverse order; again next 5 letters are written in reverse order; again next 6 letters are written in reverse order; the next 7 letters are written in reverse order and finally, the remaining letters are also written in reverse order, then what will be the 7<sup>th</sup> letter to the left of the 8<sup>th</sup> letter from right?**

- A. M
- B. N
- C. O
- D. L

**Solution: (A)**

Let us see the arrangement

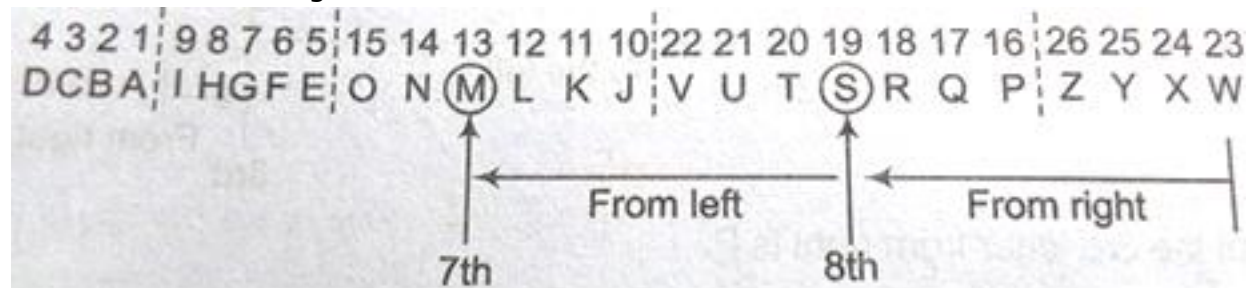

The 7<sup>th</sup> letter to the 8<sup>th</sup> letter from the right is M.



**6. Number of Letter in the Middle of Two Letters**

In this particular type, the question asked to calculate the total number of English letters between any two specified letters as directed in the question.

Four situations can be created under these types of problems

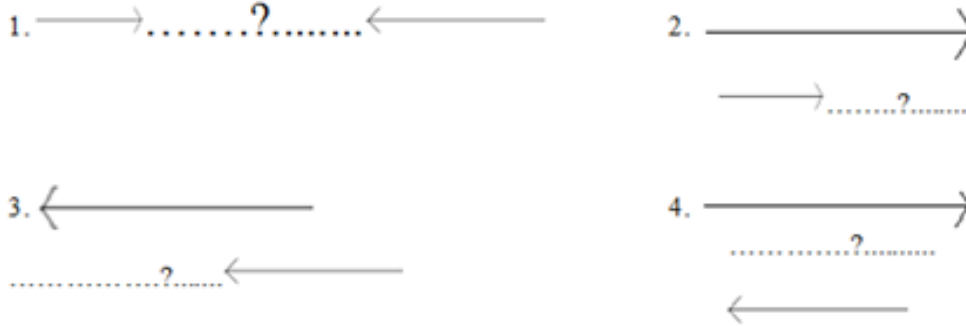

**Ex 6: How many letters are there between the 8<sup>th</sup> letter from left and the 7<sup>th</sup> letter right in the English alphabet?**

- A. 7
- B. 11
- C. 8
- D. 9

**Solution: (b)**

Let us see

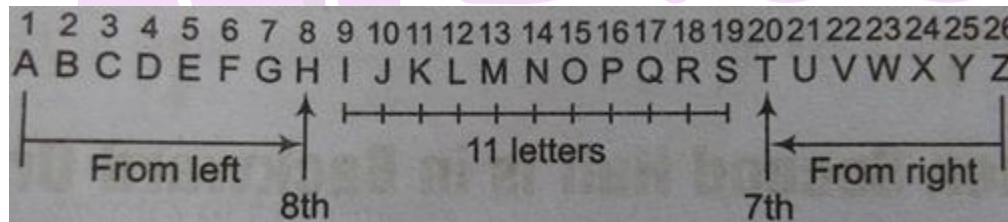

There are 11<sup>th</sup> letters between the 8<sup>th</sup> letter from left and the 7<sup>th</sup> letter from right.

**Alternate Method**

Total number of letters in the English alphabet = 26

Required number of letters = 26 - (8 + 7) = 11

**7. Middle Letter between Two letters**

In these types of questions, it is asked to find the middle letter of the two specified letters of the English alphabet.

**Ex 7: Which letter is in the middle of the 7<sup>th</sup> letter from the left and the 10<sup>th</sup> letter from the right in the English alphabet?**

- A. L
- B. P
- C. M
- D. Q

**Solution: (A)**



Let us see

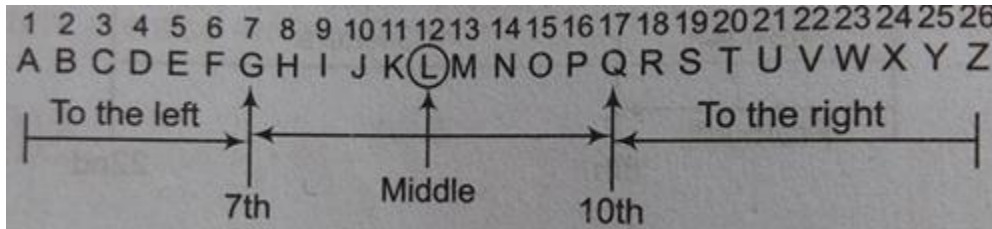

The letters between G and Q is L.

**Alternate Method**

10<sup>th</sup> letter from right = 27 - 10 = 17<sup>th</sup> letter from left.

Required middle letter =  $7 + (17 - 7) / 2 = 24 / 2 = 12^{\text{th}}$  letter from left = L

**8. Same Position of the Alphabet after Arranging Alphabetically**

A word is given in this type of question and then asked how many letters remain the same in their position if they are arranged in alphabetical order.

**Ex 8: How many such letters are there in the word 'CADMP' which remain the same in their position if they are arranged in alphabetical order?**

- A. One
- B. Two
- C. Three
- D. Four

**Solution: (C)**

Original word

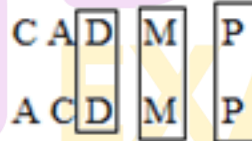

Rearrangement

So, such types of letters are D, M and P.

**Alphabet Test Reasoning Questions**

1. **Select the correct option that indicates the arrangement of the given words in the order in which they appear in an English dictionary.**

- 1. Magnetic
  - 2. Magnify
  - 3. Magnet
  - 4. Magical
  - 5. Majesty
- A. 4, 3, 2, 1, 5
  - B. 4, 3, 1, 2, 5
  - C. 4, 1, 3, 2, 5
  - D. 3, 1, 4, 2, 5

**Ans. B**



**Join Our Classroom Program Now**





2. Name a single letter that can be suffixed to the following group of letters to form new words?

Aun, Boa, Col, Dar, Dus,

- A. T
- B. C
- C. B
- D. H

**Ans. A**

3. Arrange the letter in a meaningful order

A	T	C	I	E	V
1	2	3	4	5	6

- A. 1 3 2 4 6 5
- B. 1 3 2 6 5 4
- C. 1 2 3 4 5 6
- D. 1 3 2 6 5 4

**Ans. A**

4. How many meaningful English words can be made with the letters "TAC" using each letter only once in each word?

- A. 1
- B. 2
- C. 3
- D. 4

**Ans. B**

5. Which of the following jumbled word is not a Country?

- A. DNAII
- B. NICHA
- C. PRUE
- D. KALBU

**Ans. D**

6. Find the correct order if the following five word are arranged in alphabetical order.

1. Letter 2. Paper 3. Write 4. Read 5. Draw

- A. 2, 1, 5, 3, 4
- B. 5, 1, 2, 4, 3
- C. 1, 5, 3, 2, 4
- D. 3, 2, 1, 4, 5

**Ans. B**



7.If the following five words are arranged in alphabetical order. Which word will come at the second last position?

1. Doctors 2. Teachers 3. Engineers 4. Students 5. Children

- A. Children
- B. Doctors
- C. Students
- D. Teachers

**Ans. C**

8.If the following five word are arranged in alphabetical order, then which of them comes in the middle

1. Dad 2. Dam 3. Daily 4. Damp 5. Damage

- A. Dad
- B. Dam
- C. Damp
- D. Daily

**Ans. B**

9.If the following five words are arranged in alphabetical order, then which of them comes in middle.

1. Dark 2. Data 3. Daughter 4. Danger 5. Day

- A. Daughter
- B. Dark
- C. Day
- D. Data

**Ans. D**

10.Name a single letter that can be suffixed to the following words to form new words?

MAR, MIT, LAK, HOP, SHO

- A. S
- B. W
- C. M
- D. E

**Ans. D**

11.Name a single letter that can be prefixed to the following group of letters to form new words?

Taff, Tage, Tair, Talk, Tall

- A. E
- B. C
- C. S
- D. O

**Ans. C**





12. How many such pairs of letters are there in the word STORM, each of which has as many letters between them in the word as they have between them in the English alphabet?

- A. 3
- B. 4
- C. 2
- D. 1

**Ans. A**

13. Arrange the letters in a meaningful order.

R	T	A	N	G	L	E	C	E
1	2	3	4	5	6	7	8	9

- A. 1 7 8 2 3 5 4 6 9
- B. 1 7 8 2 3 6 5 4 9
- C. 1 2 8 7 4 5 6 9 3
- D. 1 7 8 2 3 4 5 6 9

**Ans. D**

14. If the following five words are arranged in alphabetical order, then which of them comes in middle.

1. Table 2. Tank 3. Tactful 4. Talent 5. Tape

- A. Table
- B. Tactful
- C. Talent
- D. Tape

**Ans. C**

15. Which letter in the English word "ASTONISH" occupies the same position as it does in the English alphabet?

- A. S
- B. T
- C. N
- D. H

**Ans. D**

16. Choose the option which gives the correct order of the letter as indicated by the numbers to form a meaningful word.

U R T A N E  
1 2 3 4 5 6

- A. 5 4 3 2 6 1
- B. 5 4 3 1 2 6
- C. 4 5 3 2 1 6
- D. 6 1 2 3 4 5

**Ans. B**

17. How many such pairs of letters are there in the word EDUCATION, each of which has as many letters between them in the word as they have between them in the English alphabet?

- A. 3
- B. 2
- C. 4
- D. More than 4

**Ans. D**



# Buy Test Series

---

## Unlock All 650+ Mock Tests for SSC & Railway

- Unlimited Access
- All Exams covered
- Designed by Experts
- Performance Analysis